

ENVIRONMENTAL PROTECTION AGENCY



An Ghníomhaireacht um Chaomhnú Comhshaoil

**LANDFILL  
MANUALS**

**LANDFILL  
SITE DESIGN**

# Environmental Protection Agency

## Establishment

The Environmental Protection Agency Act, 1992, was enacted on 23 April, 1992, and under this legislation the Agency was formally established on 26 July, 1993.

## Responsibilities

The Agency has a wide range of statutory duties and powers under the Act. The main responsibilities of the Agency include the following:

- the licensing and regulation of large/complex industrial and other processes with significant polluting potential, on the basis of integrated pollution control (IPC) and the application of best available technologies for this purpose;
- the monitoring of environmental quality, including the establishment of databases to which the public will have access, and the publication of periodic reports on the state of the environment;
- advising public authorities in respect of environmental functions and assisting local authorities in the performance of their environmental protection functions;
- the promotion of environmentally sound practices through, for example, the encouragement of the use of environmental audits, the setting of environmental quality objectives and the issuing of codes of practice on matters affecting the environment;
- the promotion and co-ordination of environmental research;
- the licensing and regulation of all significant waste disposal and recovery activities, including landfills and the preparation and periodic updating of a national hazardous waste management plan for implementation by other bodies;
- implementing a system of permitting for the control of VOC emissions resulting from the storage of significant quantities of petrol at terminals;
- implementing and enforcing the GMO Regulations for the contained use and deliberate release of GMOs into the environment;
- preparation and implementation of a national hydrometric programme for the collection, analysis and publication of information on the levels, volumes and flows of water in rivers, lakes and groundwaters; and
- generally overseeing the performance by local authorities of their statutory environmental protection functions.

## Status

The Agency is an independent public body. Its sponsor in Government is the Department of the Environment and Local Government. Independence is assured through the selection procedures for the Director General and Directors and the freedom, as provided in the legislation, to act on its own initiative. The assignment, under the legislation, of direct responsibility for a wide range of functions underpins this independence. Under the legislation, it is a specific offence to attempt to influence the Agency, or anyone acting on its behalf, in an improper manner.

## Organisation

The Agency's headquarters is located in Wexford and it operates five regional inspectorates, located in Dublin, Cork, Kilkenny, Castlebar and Monaghan.

## Management

The Agency is managed by a full-time Executive Board consisting of a Director General and four Directors. The Executive Board is appointed by the Government following detailed procedures laid down in the Act.

## Advisory Committee

The Agency is assisted by an Advisory Committee of twelve members. The members are appointed by the Minister for the Environment and Local Government and are selected mainly from those nominated by organisations with an interest in environmental and developmental matters. The Committee has been given a wide range of advisory functions under the Act, both in relation to the Agency and to the Minister.



# **LANDFILL MANUALS**

## **LANDFILL SITE DESIGN**

**Environmental Protection Agency**

**An Gníomhaireacht um Chaomhnú Comhshaoil**

P.O. Box 3000, Johnstown Castle Estate, Co. Wexford, Ireland.

Telephone : +353-53-60600

Fax : +353-53-60699

e-mail: [info@epa.ie](mailto:info@epa.ie)

Website: [www.epa.ie](http://www.epa.ie)

© Environmental Protection Agency 2000

All or parts of this publication may be reproduced without further permission, provided the source is acknowledged.

Although every effort has been made to ensure the accuracy of the material contained in this publication, complete accuracy cannot be guaranteed. Neither the Environmental Protection Agency nor the authors accept any responsibility whatsoever for loss or damage occasioned or claimed to have been occasioned, in part or in full, as a consequence of any person acting, or refraining from acting, as a result of a matter contained in this publication. All or part of this publication may be reproduced without further permission, provided the source is acknowledged.

## LANDFILL MANUALS

### LANDFILL SITE DESIGN

Published by the Environmental Protection Agency, Ireland.

The Agency personnel involved in the preparation of this manual were Mr. Peter Carey (principal author), Mr. Gerry Carty (editor), Dr. Brian Donlon, Mr. Donal Howley, and Dr. Ted Nealon.

ISBN 1 84095 026 9  
Price Ir£15.00  
€ 19.05

12/00/750

## TABLE OF CONTENTS

|   |             |
|---|-------------|
| <b>LIST OF FIGURES</b> .....                                    | <b>.v</b>   |
| <b>LIST OF TABLES</b> .....                                     | <b>.vi</b>  |
| <b>ACKNOWLEDGEMENTS</b> .....                                   | <b>.vii</b> |
| <b>PREFACE</b> .....  | <b>.ix</b>  |
| <b>LIST OF ABBREVIATIONS</b> .....                              | <b>.x</b>   |
| <b>CHAPTER 1 INTRODUCTION</b> .....                             | <b>.1</b>   |
| <b>1.1 Introduction</b> .....                                   | <b>.1</b>   |
| <b>1.2 Waste Policy</b> .....                                   | <b>.1</b>   |
| <b>1.3 Landfill</b> .....                                       | <b>.1</b>   |
| <b>1.4 Landfill Site Design</b> .....                           | <b>.2</b>   |
| <b>CHAPTER 2 DESIGN OBJECTIVES AND CONSIDERATIONS</b> .....     | <b>.3</b>   |
| <b>2.1 Design Objectives</b> .....                              | <b>.3</b>   |
| <b>2.2 Design Considerations</b> .....                          | <b>.3</b>   |
| <b>2.3 Design Standards</b> .....                               | <b>.4</b>   |
| <b>CHAPTER 3 SITE DEVELOPMENT</b> .....                         | <b>.5</b>   |
| <b>3.1 Site Layout</b> .....                                    | <b>.5</b>   |
| <b>3.2 Site Preparation</b> .....                               | <b>.5</b>   |
| <b>3.3 Materials Requirement and Balance</b> .....              | <b>.5</b>   |
| <b>3.4 Phasing</b> .....  | <b>.7</b>   |
| <b>3.5 Cells</b> .....  | <b>.7</b>   |
| <b>3.6 Bunding</b> .....  | <b>.7</b>   |
| <b>3.7 Cover Material</b> .....                                 | <b>.9</b>   |
| <b>3.8 Landscaping</b> .....                                    | <b>.9</b>   |
| <b>CHAPTER 4 SITE INFRASTRUCTURE</b> .....                      | <b>.10</b>  |
| <b>4.1 Introduction</b> .....                                   | <b>.10</b>  |
| <b>4.2 Access and Traffic Control</b> .....                     | <b>.10</b>  |
| <b>4.3 Site Accommodation</b> .....                             | <b>.13</b>  |
| <b>4.4 Weighbridges</b> .....                                   | <b>.13</b>  |
| <b>4.5 Wheel Cleaner</b> .....                                  | <b>.14</b>  |
| <b>4.6 Site Services</b> .....                                  | <b>.14</b>  |
| <b>4.7 Civic Waste Facilities</b> .....                         | <b>.14</b>  |
| <b>4.8 Security</b> .....                                       | <b>.16</b>  |
| <b>CHAPTER 5 GROUNDWATER AND SURFACE WATER MANAGEMENT</b> ..... | <b>.18</b>  |
| <b>5.1 Introduction</b> .....                                   | <b>.18</b>  |
| <b>5.2 Groundwater Management</b> .....                         | <b>.18</b>  |
| 5.2.1 A Strategy for the Protection of Groundwater .....        | <b>.18</b>  |
| 5.2.2 Groundwater Directive .....                               | <b>.18</b>  |
| 5.2.3 Groundwater Control Measures .....                        | <b>.18</b>  |
| <b>5.3 Surface Water Management</b> .....                       | <b>.21</b>  |
| 5.3.1 Surface Water Collection System .....                     | <b>.21</b>  |
| <b>5.4 Groundwater / Surface water Monitoring Points</b> .....  | <b>.23</b>  |
| <b>CHAPTER 6 LINING SYSTEMS</b> .....                           | <b>.25</b>  |
| <b>6.1 Functions of a Lining System</b> .....                   | <b>.25</b>  |

|   |            |
|---|------------|
| <b>6.2 Requirements of Liner Systems</b> .....  | <b>.25</b> |
| 6.2.1 Hazardous Waste Landfill .....  | .25        |
| 6.2.2 Non-hazardous Biodegradable Waste Landfill .....                                    | .26        |
| 6.2.3 Inert Waste Landfill .....  | .26        |
| <b>6.3 Natural Clay</b> .....   | <b>.29</b> |
| 6.3.1 Design Parameters .....   | .29        |
| 6.3.2 Soil Classification Tests .....   | .29        |
| 6.3.3 Stress Deformation Behaviour .....  | .29        |
| 6.3.4 Hydraulic Conductivity .....  | .29        |
| 6.3.5 Construction Process .....  | .30        |
| 6.3.6 Quality Assurance Testing .....   | .32        |
| <b>6.4 Bentonite Enhanced Soils (BES)</b> .....   | <b>.33</b> |
| <b>6.5 Geosynthetic Clay Liners</b> .....   | <b>.35</b> |
| <b>6.6 Geomembranes (Flexible Membrane Liners)</b> .....                                  | <b>.36</b> |
| 6.6.1 Geomembrane Selection .....   | .36        |
| 6.6.2 Geomembrane Standards .....   | .36        |
| 6.6.3 Geomembrane Process - Raw Material to Landfill System and Installation Component .. | .37        |
| <b>6.7 Geomembrane Leak Location Surveys (GLLS)</b> .....                                 | <b>.40</b> |
| <b>6.8 Field Trials</b> .....   | <b>.40</b> |
| <b>CHAPTER 7 LEACHATE MANAGEMENT</b> .....  | <b>.43</b> |
| <b>7.1 Leachate Management</b> .....  | <b>.43</b> |
| 7.1.1 Introduction .....  | .43        |
| 7.1.2 Main Constituents .....   | .43        |
| 7.1.3 Significance of Constituents of Leachate .....                                      | .45        |
| <b>7.2 Leachate Volumes and Quality</b> .....   | <b>.49</b> |
| 7.2.1 Water Balance .....   | .49        |
| 7.2.2 Controlling Leachate Production .....   | .52        |
| <b>7.3 Leachate Collection and Removal System</b> .....                                   | <b>.52</b> |
| 7.3.1 Introduction .....  | .52        |
| 7.3.2 Design Features and Recommended Minimum Standards .....                             | .54        |
| 7.3.3 Sources of Clogging .....   | .55        |
| 7.3.4 Preventative Measures to Reduce Clogging .....                                      | .56        |
| 7.3.5 Leachate Removal .....  | .56        |
| 7.3.6 Monitoring of Leachate in Landfill .....  | .60        |
| <b>7.4 Leachate Storage</b> .....   | <b>.60</b> |
| <b>7.5 Recirculation of Leachate</b> .....  | <b>.60</b> |
| <b>CHAPTER 8 LEACHATE TREATMENT</b> .....   | <b>.63</b> |
| <b>8.1 Introduction</b> .....   | <b>.63</b> |
| <b>8.2 Physical - Chemical Pretreatment</b> .....   | <b>.63</b> |
| 8.2.1 Air Stripping of Methane .....  | .63        |
| 8.2.2 Air Stripping of Ammonia .....  | .63        |
| 8.2.3 Precipitants / Flocculants .....  | .64        |
| <b>8.3 Biological Treatment of Leachate</b> .....   | <b>.65</b> |
| 8.3.1 Activated Sludge .....  | .65        |
| 8.3.2 Sequencing Batch Reactors .....   | .66        |
| 8.3.3 Aeration Lagoons .....  | .66        |
| 8.3.4 Rotating Biological Contactors .....  | .67        |
| 8.3.5 Combined Leachate and Urban Wastewater Treatment .....                              | .68        |
| 8.3.6 Anaerobic Treatment .....   | .68        |
| 8.3.7 Biological Nitrogen Removal .....   | .68        |

|   |            |
|---|------------|
| <b>8.4 Physical-Chemical / Biological Treatment of Leachate</b> ..... | <b>.69</b> |
| 8.4.1 Membrane Bioreactor .....                                       | .69        |
| 8.4.2 Powdered Activated Carbon (Biological) .....                    | .70        |
| 8.4.3 Filtration .....  | .70        |
| 8.4.4 Other Treatment Systems .....                                   | .70        |
| <b>8.5 Advanced Treatment methods</b> .....                           | <b>.70</b> |
| 8.5.1 Activated Carbon Adsorption .....                               | .70        |
| 8.5.2 Reverse Osmosis .....   | .71        |
| 8.5.3 Chemical Oxidation .....  | .73        |
| 8.5.4 Evaporation .....   | .73        |
| 8.5.5 Reed Bed Treatment .....  | .73        |
| <b>8.6 Residuals Management</b> .....                                 | <b>.75</b> |
| <b>8.7 Life Cycle Considerations</b> .....                            | <b>.75</b> |
| <br>  |            |
| <b>CHAPTER 9 LANDFILL GAS MANAGEMENT</b> .....                        | <b>.77</b> |
| <b>9.1 Introduction</b> .....   | <b>.77</b> |
| <b>9.2 Objectives of a Landfill Gas Management System</b> .....       | <b>.77</b> |
| <b>9.3 Quantity of Landfill gas Generated</b> .....                   | <b>.77</b> |
| <b>9.4 Landfill Gas Control</b> .....                                 | <b>.79</b> |
| <b>9.5 Landfill Gas Barriers</b> .....                                | <b>.80</b> |
| <b>9.6 Landfill Gas Venting</b> .....                                 | <b>.80</b> |
| <b>9.7 Landfill Gas Collection</b> .....                              | <b>.80</b> |
| 9.7.1 Gas Wells .....   | .82        |
| 9.7.2 Well Heads .....  | .82        |
| 9.7.3 Collector Pipes .....   | .83        |
| 9.7.4 Condensate Removal .....  | .83        |
| 9.7.5 Extraction Pumps .....  | .83        |
| 9.7.6 Commissioning / Decommissioning .....                           | .84        |
| <b>9.8 Utilisation of Landfill Gas</b> .....                          | <b>.84</b> |
| <b>9.9 Landfill Gas Flares</b> .....                                  | <b>.84</b> |
| <b>9.10 Landfill Gas Monitoring</b> .....                             | <b>.85</b> |
| <b>9.11 Landfill Gas Safety</b> .....                                 | <b>.86</b> |
| <br>  |            |
| <b>CHAPTER 10 CAPPING DESIGN &amp; CONSTRUCTION</b> .....             | <b>.94</b> |
| <b>10.1 Introduction</b> .....  | <b>.94</b> |
| <b>10.2 Objectives of Capping</b> .....                               | <b>.94</b> |
| <b>10.3 Capping System Design Considerations</b> .....                | <b>.94</b> |
| <b>10.4 Components of Capping Systems</b> .....                       | <b>.94</b> |
| 10.4.1 Topsoil and Subsoil .....                                      | .94        |
| 10.4.2 Drainage Layer .....   | .95        |
| 10.4.3 Barrier Layer .....  | .95        |
| 10.4.4 Gas Collection Layer .....                                     | .95        |
| 10.4.5 Filter Material .....  | .95        |
| <b>10.5 Recommended Capping Systems</b> .....                         | <b>.95</b> |
| 10.5.1 Hazardous Landfill Capping System .....                        | .95        |
| 10.5.2 Non-Hazardous Biodegradable Landfill Capping System .....      | .96        |
| 10.5.3 Inert Landfill Capping System .....                            | .96        |
| <b>10.6 Cap Stability</b> .....                                       | <b>.96</b> |
| <b>10.7 Settlement</b> .....  | <b>.96</b> |
| <br>  |            |
| <b>CHAPTER 11 QUALITY ASSURANCE &amp; QUALITY CONTROL</b> .....       | <b>.98</b> |
| <b>11.1 Introduction</b> .....  | <b>.98</b> |
| <b>11.2 Definitions</b> .....   | <b>.98</b> |

|   |             |
|---|-------------|
| <b>11.3 Quality Assurance/Quality Control Plan</b> .....  | <b>.98</b>  |
| 11.3.1 Structural Organisation of a QA/QC Plan and Staffing .....   | .98         |
| 11.3.2 Licensing Authority .....  | .100        |
| 11.3.3 Components of a QA/QC Plan .....   | .100        |
| <b>11.4 Commissioning</b> .....   | <b>.101</b> |
| <b>CHAPTER 12 HEALTH &amp; SAFETY</b> .....   | <b>.102</b> |
| <b>12.1 Introduction</b> .....  | <b>.102</b> |
| <b>12.2 Safety, Health and Welfare at Work Act, 1989</b> .....  | <b>.102</b> |
| <b>12.3 The Safety, Health and Welfare at Work (Construction Sites) Regulations, 1995</b> .....   | <b>.102</b> |
| <b>GLOSSARY</b> .....   | <b>.105</b> |
| <b>REFERENCES AND FURTHER READING</b> .....   | <b>.111</b> |
| <b>APPENDIX A: STORAGE BUNDS</b> .....  | <b>.117</b> |
| <b>A.1 Bund Testing</b> .....   | <b>.118</b> |
| <b>APPENDIX B: GROUNDWATER/SURFACE WATER MANAGEMENT</b> .....   | <b>.119</b> |
| <b>B.1 Groundwater Control methods</b> .....  | <b>.120</b> |
| <b>APPENDIX C: LINING SYSTEMS</b> .....   | <b>.123</b> |
| <b>C.1 Testing of Clay Liners</b> .....   | <b>.124</b> |
| C.1.1 Suitability Testing .....   | .124        |
| C.1.2 Acceptability Testing .....   | .124        |
| <b>C.2 Geomembranes</b> .....   | <b>.127</b> |
| <b>C.3 Leakage Through Liners</b> .....   | <b>.128</b> |
| C.3.1 Calculated Rate of Leakage Per Unit Area for Various Thickness of Mineral Liner .....   | .128        |
| C.3.2 Calculated Rate of Leakage Per Unit Area for Various Leachate Head Levels Through<br>a 1m Thick Mineral Liner with a Hydraulic Conductivity of $1 \times 10^{-9}$ m/s ..... | .129        |
| C.3.3 Leakage Rates Through Composite Liners .....  | .129        |
| <b>APPENDIX D: LEACHATE MANAGEMENT/TREATMENT</b> .....  | <b>.132</b> |
| <b>D.1 Constituents of Inert and Hazardous Leachate</b> .....   | <b>.133</b> |
| <b>D.2 Comparative Performance of Various Treatment Processes for Leachate Treatment</b> .....  | <b>.134</b> |
| <b>D.3 Monitoring Requirements</b> .....  | <b>.136</b> |
| <b>APPENDIX E: LANDFILL GAS MANAGEMENT</b> .....  | <b>.137</b> |



## LIST OF FIGURES

|                 |   |     |
|-----------------|---|-----|
| Figure 3.1:     | Diagrammatic Layout of a Landfill   | 6   |
| Figure 3.2:     | Phasing of a Landfill Development   | 8   |
| Figure 4.1:     | Schematic of Typical Access, Service and Haul Roads   | 11  |
| Figure 4.2:     | Typical Access Ramp   | 12  |
| Figure 4.3:     | Wheelcleaning Arrangements  | 15  |
| Figure 4.4:     | Typical Civic Waste Facility Layout   | 17  |
| Figure 5.1:     | Groundwater Conditions  | 20  |
| Figure 5.2:     | Typical Cut Off Drain   | 21  |
| Figure 5.3:     | Methods for Surface Water Control   | 24  |
| Figure 6.1(A):  | Lining Systems for Hazardous Waste Landfills  | 27  |
| Figure 6.1 (B): | Lining Systems for Non-Hazardous and Inert Waste Landfills  | 28  |
| Figure 6.2:     | Effect of Moisture Content and Compactive Energy on Hydraulic Conductivity for a Silty Clay (After Mitchell, Hooper and Campanella, 1965)               | 31  |
| Figure 6.3:     | Typical Anchor Trench Detail  | 42  |
| Figure 6.4:     | Typical Weld Details  | 42  |
| Figure 7.1:     | Major Stages of Waste Degradation   | 44  |
| Figure 7.2:     | Changes in Leachate Composition (Source UK DOE 1991)  | 45  |
| Figure 7.3:     | Relationship Between Waste Density and the Absorptive Capacity of Waste   | 51  |
| Figure 7.4:     | Typical Leachate Collection and Removal System  | 53  |
| Figure 7.5:     | Mound Model to Determine Pipe Spacing   | 55  |
| Figure 7.6:     | Leachate Collection Sump and Pipe Riser Going Up the Side Slope   | 57  |
| Figure 7.7:     | Secondary Leak Detection Removal Systems (Hazardous Landfills Only)   | 58  |
| Figure 7.8:     | General Arrangement of Leachate Pumping Chamber   | 59  |
| Figure 7.9:     | Typical Leachate Monitoring Chamber Details   | 62  |
| Figure 8.1:     | Activated Sludge Process  | 65  |
| Figure 8.2:     | Sequencing Batch Reactor  | 66  |
| Figure 8.3:     | Rotating Biological Contactor   | 67  |
| Figure 8.4:     | Membrane Bioreactor System  | 69  |
| Figure 8.5:     | Schematic Representation of Activated Carbon Treatment System   | 72  |
| Figure 8.6:     | Reverse Osmosis Treatment System  | 72  |
| Figure 8.7:     | Reed Bed System   | 74  |
| Figure 8.8:     | Leachate Treatment - Schematic of the Design Process  | 76  |
| Figure 9.1:     | Limits of Flammability of Mixtures of Methane, Air and Nitrogen   | 78  |
| Figure 9.2:     | Passive Gas Venting (Into Waste)  | 81  |
| Figure 9.3:     | Passive Gas Control System (Venting to Atmosphere From Gas Drainage Layer)  | 81  |
| Figure 9.4:     | Example of a Vertical Gas Well Arrangement  | 87  |
| Figure 9.5:     | Example of Horizontal Well  | 87  |
| Figure 9.6:     | Example of a Hybrid Well Arrangement  | 88  |
| Figure 9.7:     | Example of a Gabion Gas Well Arrangement  | 89  |
| Figure 9.8:     | Typical Well Head for Landfill Gas  | 89  |
| Figure 9.9:     | Landfill Gas Condensate Traps   | 90  |
| Figure 9.10:    | Typical Condensate Reservoir Complete with Syphon   | 90  |
| Figure 9.11:    | Illustration of Landfill Gas Development & Production Options   | 91  |
| Figure 9.12:    | Schematic Diagram of a Landfill Gas Flare   | 92  |
| Figure 9.13:    | Typical Landfill Gas Monitoring Borehole (Outside Waste Body)   | 93  |
| Figure 10.1:    | Landfill Capping Systems  | 97  |
| Figure 11.1:    | Quality Control / Assurance   | 99  |
| Figure B.1:     | Approximate Range of Application of Groundwater Control Techniques in Soils   | 122 |
| Figure C.1:     | Calculated Rate of Leakage Per Unit Area for Various Thicknesses of Mineral Liner   | 128 |
| Figure C.2:     | Calculated Rate of Leakage Per Unit Area for Various Heads of Leachate  | 129 |
| Figure C.3:     | Value of $I_{AVG}$  | 131 |
| Figure C.4:     | Leakage Rates for Variation in Hydraulic Head and Hydraulic Conductivity for a Composite Liner With Good Contact Between Geomembrane and Soil Component | 131 |

## LIST OF TABLES

|             |   |     |
|-------------|---|-----|
| Table 4.1:  | Weighbridge Types:- Advantages/Disadvantages . . . . .  | 14  |
| Table 6.1:  | Soil Classification Tests . . . . .   | 32  |
| Table 6.2:  | Typical Suitable Ranges for Parameters of Clay . . . . .  | 32  |
| Table 6.3:  | Recommended Minimum Testing Frequencies for Investigation of Borrow Source . . . . .  | 34  |
| Table 6.4:  | Recommended Materials Tests for Soil Liner Materials Sampled After Placement in a Loose Lift (Just Before Compaction) . . . . .       | 34  |
| Table 6.5:  | Recommended Maximum Allowance Variation for Materials Sampled After Placement in a Loose Lift (Just Before Compaction) . . . . .      | 34  |
| Table 6.6:  | Recommended Minimum Testing Frequencies on Compacted Soil . . . . .   | 34  |
| Table 6.7:  | Recommended Maximum Allowance Variation . . . . .   | 35  |
| Table 6.8:  | Recommended Bentonite Content Test for BES Liner Materials Sampled After Placement in a Loose Lift (Just before Compaction) . . . . . | 35  |
| Table 6.9:  | Geomembrane Bonding Methods . . . . .   | 38  |
| Table 7.1:  | Summary of Composition of Acetogenic Leachates Sampled from Large Landfills with a Relatively Dry High Waste Input Rate . . . . .     | 47  |
| Table 7.2:  | Summary of Composition of Methanogenic Leachates Sampled from Large Landfills with a Relatively Dry High Waste Input Rate . . . . .   | 48  |
| Table 7.3:  | Typical Water Balance Calculation . . . . .   | 50  |
| Table 7.4:  | Characteristics of Leachate that are Potential Clogging Mechanisms . . . . .  | 55  |
| Table 8.1:  | Leachate Treatment Methods and Objectives . . . . .   | 64  |
| Table 8.2:  | Design Criteria for Activated Sludge Plants . . . . .   | 65  |
| Table 8.3:  | Design Criteria for Sequencing Batch Reactor . . . . .  | 66  |
| Table 8.4:  | Design Criteria for RBC . . . . .   | 68  |
| Table 8.5:  | Design Criteria for Powdered Activated Carbon System . . . . .  | 70  |
| Table 9.1:  | Model Input Data . . . . .  | 79  |
| Table 9.2:  | Monitoring Combustion Products From Flare Units . . . . .   | 85  |
| Table 11.1: | Responsibilities of Those Involved in Development of a Landfill . . . . .   | 100 |
| Table 12.1: | Health, Safety and Welfare at Work (Construction Regulations) 1995 Summary of Main Duties . . . . .                                   | 103 |
| Table B.1:  | Physical Cut-Off Techniques for Exclusion of Groundwater . . . . .  | 120 |
| Table B.2:  | Summary of Principal Pumped Well Groundwater Control Methods . . . . .  | 121 |
| Table C.1:  | Advantages/Disadvantages of Basic Polymers of Geomembranes . . . . .  | 127 |
| Table C.2:  | Relationship Between Liner Thickness and Rate of Leakage Per Unit Area . . . . .  | 128 |
| Table C.3:  | Relationship Between Leachate Head and Rate of Leakage Per Unit Area . . . . .  | 129 |
| Table C.4:  | Leakage Rate Per Unit Area in Litre per Hectare Per Day . . . . .   | 130 |
| Table D.1:  | Constituents of Inert and Hazardous Leachate . . . . .  | 133 |
| Table D.2:  | Comparative Performance of Various Treatment Processes for Leachate Treatment . . . . .   | 134 |
| Table E.1:  | Typical Landfill Gas Composition (Source UK DOE) . . . . .  | 138 |
| Table E.2:  | Typical Instrumentation for Use with Landfill Gas . . . . .   | 138 |

## ACKNOWLEDGEMENTS

The Agency wishes to acknowledge those who contributed to and reviewed this manual. A review panel was established by the Agency to assist in the finalisation of the manual and we acknowledge below the contribution of those persons who took the time to offer information, advice and in many cases comments and constructive criticism on the draft manual. We gratefully acknowledge the assistance offered by the following persons:

|   |   |
|---|---|
| Mr. Eamon Timoney / Mr. Declan O Sullivan | Fehily Timoney & Co.  |
| Mr. Larry O Toole / Mr. Donal Cronin      | M. C. O Sullivan & Co. Ltd.   |
| Mr. Mike Long                             | University College Dublin   |
| Dr. Michael Rodgers                       | National University of Ireland, Galway                                |
| Mr. Declan Mc Grath / Mr. Chris Long      | FLI International   |
| Mr. Con Crotty / Mr. Niall Troy           | Lining Services (Waterford) Ltd.                                      |
| Mr. Mike Everest                          | GSE Lining Technology Ltd.  |
| Mr. Garret Fallon                         | Wimpey EPC Ltd (now Irish Power Systems Ltd.)                         |
| Mr. Michael O Leary                       | South Dublin County Council (now Wicklow County Council)              |
| Mr. Gerry Duane                           | Fingal County Council   |
| Mr. Bruce Misstear                        | Trinity College Dublin  |
| Mr. Larry Kelly                           | Institute of Engineers of Ireland Continuing Education Committee      |
| Dr. Bryan Gregory                         | Kirk McClure Morton   |
| Mr. Ray Mc Gee                            | Department of the Environment & Local Government                      |
| Mr. Damien Greham                         | Tobin Environmental Services  |
| Dr. Mike Barr                             | Aspinwall & Company   |
| Mr. Geoff Parker                          | K.T. Cullen & Co. Ltd. (now Environment and Resource Management Ltd.) |
| Mr. Roger Dixon                           | B & M Pipeline Services Limited                                       |

The Agency also wishes to acknowledge the assistance of the South East Regional Environmental Committee and the Institute of Engineers (Geotechnical Society) who submitted comments and constructive suggestions.

The assistance of the following people within the Agency is also acknowledged for reviewing the document and providing useful comments and information:

Ms. Ann Butler  
 Dr. Jonathan Derham  
 Dr. Duncan Laurence (now Duncan Laurence Environmental)  
 Mr. Dara Lynott  
 Mr. Tadgh O Mahony



## PREFACE

The Environmental Protection Agency was established in 1993 to license, regulate and control activities for the purpose of protecting the environment. Section 62 of the Environmental Protection Agency Act, 1992, states that *"the Agency shall, as soon as practicable, specify and publish criteria and procedures for the selection, management, operation and termination of use of landfill sites for the purpose of environmental protection"*. These criteria and procedures are being published in a number of manuals under the general heading of LANDFILL MANUALS.

The purpose of this manual is to provide guidance on landfill site design so as to prevent or reduce as far as possible negative effects on the environment. Guidelines are presented for the design of landfill liner systems, leachate management systems, for landfill gas management and for the final capping system. Information on quality assurance and quality control procedures to be followed to validate the construction process is also included. It provides detailed information on the design process as it progresses from site development through to the stage of final capping.

Manuals on *Investigations for Landfills*, *Landfill Monitoring*, *Landfill Operational Practices*, *Landfill Restoration and Aftercare* have been published by the Agency while manuals on Site Selection and Waste Acceptance are also being finalised for publication. Given that this Landfill Site Design Manual is one of a series, it is important that this document is read in conjunction with other available publications.

Future Irish landfills will be developed, managed, monitored and subjected to aftercare procedures within the Waste Management Act, 1996 and the requirements of the EU Directive on the Landfilling of Waste. This manual is being published to assist in meeting the statutory obligations of Section 62 of the Environmental Protection Agency Act, 1992. It is intended to be a nationally adopted guidance manual for use by those involved in the design of landfills.

The current standard of operation of many landfills is unsatisfactory and significant improvements are required if we are to meet the higher standards proposed in the national legislation and EU directives. To meet these standards, a thorough, professional and consultative approach to the selection, operation, management and aftercare of our landfills is required. Our determination to deal with waste in a responsible manner should be reflected in our approach to all aspects of the planning and management of existing and proposed landfills.

## LIST OF ABBREVIATIONS

|          |  |
|----------|--|
| AOX:     | Adsorbable organic halogens                                |
| ASTM:    | American Society for Testing and Materials                 |
| BATNEEC: | Best available technology not entailing excessive cost     |
| BES:     | Bentonite enhanced soil                                    |
| BOD:     | Biochemical oxygen demand                                  |
| cc:      | Cubic centimeter   |
| BSI:     | British Standards Institute                                |
| CCTV:    | Closed circuit television                                  |
| CIRIA    | Construction Industry Research and Information Association |
| COD:     | Chemical oxygen demand                                     |
| CQA:     | Construction quality assurance                             |
| CQC:     | Construction quality control                               |
| CSPE:    | Chlorosulfonated polyethylene                              |
| DGM:     | Digital ground model                                       |
| dti:     | Department of trade and industry (UK)                      |
| DTM:     | Digital terrain model                                      |
| EIS:     | Environmental Impact Statement                             |
| EPA:     | Environmental Protection Agency                            |
| ETSU     | Energy Technology Support Unit (UK)                        |
| FML:     | Flexible membrane liner (also called a geomembrane)        |
| FSR:     | Flood Studies Report                                       |
| GCL:     | Geosynthetic clay liner                                    |
| GLLS:    | Geomembrane leak location surveys                          |
| GRI:     | Geosynthetic Research Institute                            |
| HDPE:    | High density polyethylene                                  |
| HHW:     | Household hazardous waste                                  |
| IEI:     | Institute of Engineers of Ireland                          |
| LCRS:    | Leachate collection and removal system                     |
| LEL:     | Lower Explosive Limit                                      |
| LFG:     | Landfill gas   |
| LLDPE:   | Linear low density polyethylene                            |
| MCV:     | Moisture condition value                                   |
| MDPE:    | Medium density polyethylene                                |
| MQA:     | Manufacturing quality assurance                            |
| MQC:     | Manufacturing quality control                              |
| NRA:     | National Roads Authority                                   |
| NSF:     | National Sanitation Foundation                             |
| NTP:     | Normalised temperature and pressure                        |
| PE:      | Polyethylene   |
| PS(C):   | Project Supervisor Construction                            |
| PS(D):   | Project Supervisor Design                                  |
| PVC:     | Polyvinyl chloride   |
| QA:      | Quality assurance  |
| QC:      | Quality control  |
| TOC:     | Total organic carbon                                       |
| TRL:     | Transport Research Laboratory                              |
| UEL:     | Upper Explosive Limit                                      |
| WMA:     | Waste Management Act, 1996                                 |
| WWTP:    | Waste water treatment plant                                |

# 1. INTRODUCTION

## 1.1 INTRODUCTION

The Environmental Protection Agency (EPA) is required, under the Environmental Protection Agency Act, 1992 to specify and publish criteria and procedures for the selection, management, operation and termination of use of landfill sites. This document on 'Landfill Site Design' is one of a series of manuals on landfilling which have been published to fulfill the Agency's statutory requirements.

In the past, many of the problems associated with landfills occurred as a result of non engineered facilities and poor management. It is imperative that issues outlined in this manual and the other landfill manuals are considered in full in the design and the development of the landfill.

There are many potential environmental problems associated with the landfilling of waste. These problems are often long-term and include possible contamination of the groundwater and surface water regimes, the uncontrolled migration of landfill gas and the generation of odour, noise and visual nuisances.

This manual, along with the others in the series, has been prepared to assist landfill operators to conform to the standards required, including the BATNEEC principle, and to ensure that the long-term environmental risks posed by landfills (including closed landfills) are minimised through effective containment, monitoring, and control.

## 1.2 WASTE POLICY

Ireland's waste policy is outlined in the document '*Waste Management - A Policy Statement -changing our ways*' (1998) which builds on earlier strategies including '*Sustainable Development - A Strategy for Ireland*' adopted by the Government in 1997. National policy in relation to waste management is based on a hierarchy of principles agreed by the European Union. Our priorities are:

- prevention of waste generation and reduction at source;
- waste recovery through reuse, recycling and energy recovery; and

- safe disposal of any remaining non-recoverable wastes.

The primary purposes of the Policy Statement is to provide a national framework within which local authorities, and the waste industry can plan ahead with confidence. This includes reducing our current overwhelming reliance on landfill, which accounts for 92% of municipal waste. Landfill must become a subsidiary element of an integrated waste infrastructure, catering only for residual waste which cannot be prevented or otherwise treated.

A sustainable approach to waste management in Ireland is being developed through the Environmental Protection Agency Act, 1992 and the Waste Management Act, 1996.

The Waste Management Act, 1996 provides for the introduction of:

- measures designed to improve national performance in relation to the prevention, reduction and recovery of waste; and
- a regulatory framework for the application of higher environmental standards, particularly in relation to waste disposal.

Waste Management Plans, which Local Authorities are responsible for preparing under Section 22 of the Waste Management Act, 1996 and the Waste Management (Planning) Regulations, 1997; must have particular regard to waste prevention and waste recovery. Section 26 of the Waste Management Act, 1996 requires the Environmental Protection Agency to prepare a national hazardous waste management plan. This must also have particular regard to prevention and minimisation of the production of hazardous waste and to the recovery of hazardous waste.

## 1.3 LANDFILL

EC Directive 75/442/EEC requires all Member States to take appropriate measures to establish an integrated and adequate network of waste disposal installations which will allow the Community to become self-sufficient as regards the disposal of waste.

In the communication from the Commission on the review of the Community Waste Strategy (COM (96) 399 final) landfill represents the option of last resort. The Council adopted the directive on the landfill of waste in 1999 (Council Directive 99/31/EC). This Directive aims:

- to ensure high standards for the disposal of waste in the European Union;
- to stimulate waste prevention via recycling and recovery of waste; and
- to create a uniform cost for the disposal of waste which consequently will prevent the unnecessary transport of waste.

The Waste Management Act, 1996 designates the Agency the sole licensing authority for landfills. The Waste Management (Licensing) Regulations, 1997 provide for the commencement and operation of the system of licensing by the Agency of waste recovery and disposal activities. Through licensing, control and active management, the standards of design and operation of landfills should improve.

#### **1.4 LANDFILL SITE DESIGN**

Good design of a landfill site will prevent, or reduce as far as possible, negative effects on the environment, as well as the risks to human health arising from the landfilling of waste. It is essential that the designer adopt methods, standards and operational systems based on best current practice which reflect progress in management techniques and containment standards. The design process should be consistent with the need to protect the environment and human health.

Landfill design is an interactive process incorporating the conceptual design proposals, the findings of the environmental assessment and environmental monitoring results, risk assessment and the conclusions reached in investigations. The fundamental objective behind waste management is that of sustainability. It is implicit therefore that landfill development and operation (which are intrinsically linked) should reflect this approach.

This manual outlines the design objectives and considerations that need to be taken into account in the design of a landfill. Management systems for the control of leachate, gas, surface water and groundwater are discussed. The design of engineering works associated with lining and capping systems is considered.



## 2. DESIGN OBJECTIVES AND CONSIDERATIONS

### 2.1 DESIGN OBJECTIVES

The primary objective of landfill site design is to provide effective control measures to prevent or reduce as far as possible negative effects on the environment, in particular the pollution of surface water, groundwater, soil and air, as well as the resulting risks to human health arising from landfilling of waste.

The design concept for a landfill depends on the ground conditions, the geology and hydrogeology of the site, the potential environmental impacts and the location of the landfill. The investigations for a landfill should provide sufficient information to enable the formulation of a site specific design.

Landfill practice is dynamic in that it will change with both advances in technology and changes in legislation. To incorporate such advances and changes a periodic review of the design should be carried out, as the lifespan of a landfill site from commencement to completion is long compared to other construction projects. Generally, landfills are constructed on a phased basis.

### 2.2 DESIGN CONSIDERATIONS

The designer should consider all environmental media that may be significantly impacted through the life of the landfill. The chosen design will have a major influence on the operation, restoration and aftercare of the facility. Aspects that must be considered in the design are briefly discussed below.

- **Nature and quantities of waste**

The waste types accepted at the landfill will dictate the control measures required. The requirements at a landfill accepting inert waste will be different to those at one accepting non-hazardous biodegradable waste which in turn will be different from a facility accepting hazardous waste.

- **Water control**

To reduce leachate generation, control measures may be required to minimise the quantity of precipitation, surface water and groundwater entering the landfilled waste. Contaminated water will need to be collected and treated prior to discharge.

- **Protection of soil and water**

A liner must be provided for the protection of soil, groundwater and surface water. The liner system may consist of a natural or artificially established mineral layer combined with a geosynthetic liner that must meet prescribed permeability and thickness requirements.

- **Leachate management**

An efficient leachate collection system may have to be provided to ensure that leachate accumulation at the base of the landfill is kept to a minimum. The leachate system may consist of a leachate collection layer with a pipe network to convey the leachate to a storage or treatment facility.

- **Gas control**

The accumulation and migration of landfill gas must be controlled. Landfill gas may need to be collected with subsequent treatment and utilisation, or disposal in a safe manner through flaring or venting.

- **Environmental nuisances**

Provisions should be incorporated in the design to minimise and control nuisances arising from the construction, operation, closure and aftercare phases of the landfill. Nuisances that may arise from landfilling include; noise, odours, dust, litter, birds, vermin and fires.

- **Stability**

Consideration must be given to the stability of the subgrade, the basal liner system, the waste mass and the capping system. The subgrade and the basal liner should be sufficiently stable to prevent excessive settlement or slippages. The hydraulic uplift pressure on the lining system due to groundwater must be considered. The method of waste emplacement should ensure stability of the waste mass against sliding and rotational failure. The capping system should be designed to ensure stability against sliding.

- **Visual appearance and landscape**

Consideration should be given to the visual appearance of the landform during operation and at termination of landfilling and its impact on the surrounding landforms.

- **Operational and restoration requirements**

The designer must consider the manner of site development and the necessary site infrastructural requirements during landfill operation and restoration. Landfill sites should be developed on a phased basis. Site infrastructure should include for the provision of; site accommodation, weighbridge, waste inspection area, wheelwash, site services and security fencing.

- **Monitoring requirements**

The designer should consider monitoring requirements at the design stage. These should be consistent with the requirements outlined in the Agency's manual on '*Landfill Monitoring*'.

- **Estimated cost of the facility**

The designer should estimate the cost of the total project (construction, operation, closure and aftercare) from commencement to completion. This should include the costs of planning, site preparation and development works, operational works, restoration/capping works, landfill aftercare, and monitoring. Consideration should be given to the financing of the facility at the design stage in order to ensure that sufficient funds can be generated to fund ongoing and potential liabilities.

- **Afteruse**

The designer should consider the intended afteruse of the facility. It should be compatible with the material components and physical layout of the capping system, the surrounding landscape and current landuse zoning as specified in the relevant development plan.

- **Construction**

Environmental effects during construction must be considered. These may include noise from machinery, dust from soil excavation and soil placement, disturbance, traffic diversion, and avoidance of pollution by construction related activities.

- **Risk Assessment**

The design and engineering of a landfill should be supported by a comprehensive assessment of the risk of adverse environmental impacts or harm to human health resulting from the proposed development.

## 2.3 DESIGN STANDARDS

Standards for design are necessary to ensure a consistent approach to landfill design. The introduction of standards should assist in the improvement of landfills and prevent or reduce negative effects on the environment.

Standards and procedures used include:

- **Absolute standards**

Designers should use, where possible, relevant Irish, European, or International Standards published by recognised bodies. The designer should ensure that standards used are current.

- **Performance specifications**

Performance specifications may be drawn up and used for specific topics. Leachate control equipment and gas utilisation equipment are examples where performance specifications are used.

- **Guidelines**

A number of guidelines on different aspects of landfill design are available. This manual is intended to serve a dual function of outlining the general process of design and providing relevant information.

- **Quality Assurance and Quality Control Procedures**

Quality assurance and quality control are integral parts of a landfill design scheme. Quality assurance/quality control plans should be used to ensure that the design and construction of the facility is carried out to a satisfactory standard.

## 3. SITE DEVELOPMENT

### 3.1 SITE LAYOUT

The landfill design should enable a practicable operation of the facility. The site layout plan should show clearly the location of the area to be landfilled.

The production of a digital ground model (DGM), also referred to as digital terrain model (DTM), or topographical map should be undertaken during the investigations stage. Typical scales used are 1:500 or 1:2500 for larger sites (greater than 60 hectares). Contour intervals vary depending on ground elevation. Sites with little topographical relief (almost level) may have contour intervals at 0.25m, while sites with high topographical relief may have contours at intervals of 0.5m or 1.0m.

A diagrammatic landfill layout is presented in Figure 3.1.

### 3.2 SITE PREPARATION

The extent of preparatory works is site specific and should be determined during the investigation stage. The preparatory works will include the stripping/filling of soil to formation level for the:

- lining system for cell/phase construction;
- leachate and gas management facilities;
- groundwater, surface water and leachate systems;
- landscaping and screening; and
- all other site infrastructure.

Existing services located within the proposed area of waste disposal must be relocated. Borehole installations within this area should be grouted up to prevent a direct conduit to the groundwater.

### 3.3 MATERIALS REQUIREMENT AND BALANCE

Materials (soils, etc.) are required at all stages of landfill development (construction, operation and restoration). It is important that the designer estimate the quantities of material required, the quantities arising from site development, the quantities of suitable usable material available on site and, if necessary, the deficit between suitable

material available and that required. If there is a material deficit it will be necessary to import material to achieve the balance. An appropriate off-site source of the material required should be identified. If there is a material excess the disposal of such material should be planned for.

The investigation stage of the design process should include a detailed geotechnical assessment. Such an assessment should include trial pits; boreholes; *in situ* tests; sampling; laboratory testing and compaction trials. This would assist the designer in:

- determining the suitability of *in situ* materials (type and quantity) for use in the construction, operation and restoration of the landfill facility; and
- carrying out a materials balance on a phase by phase basis.

Materials are required during landfill development for:

- basal mineral liner;
- cap barrier layer;
- leachate drainage blanket;
- other drainage layers e.g. capping layer and groundwater/surface water;
- gas collection and venting system;
- roads;
- cover (daily, intermediate);
- embankments;
- internal and external bunds; and
- restoration layers (subsoil and topsoil).

Materials required for the above operations may need to be stored on site for a period of time. The material should be stored in a manner that maximises its reuse potential.

FIGURE 3.1: DIAGRAMMATIC LAYOUT OF A LANDFILL

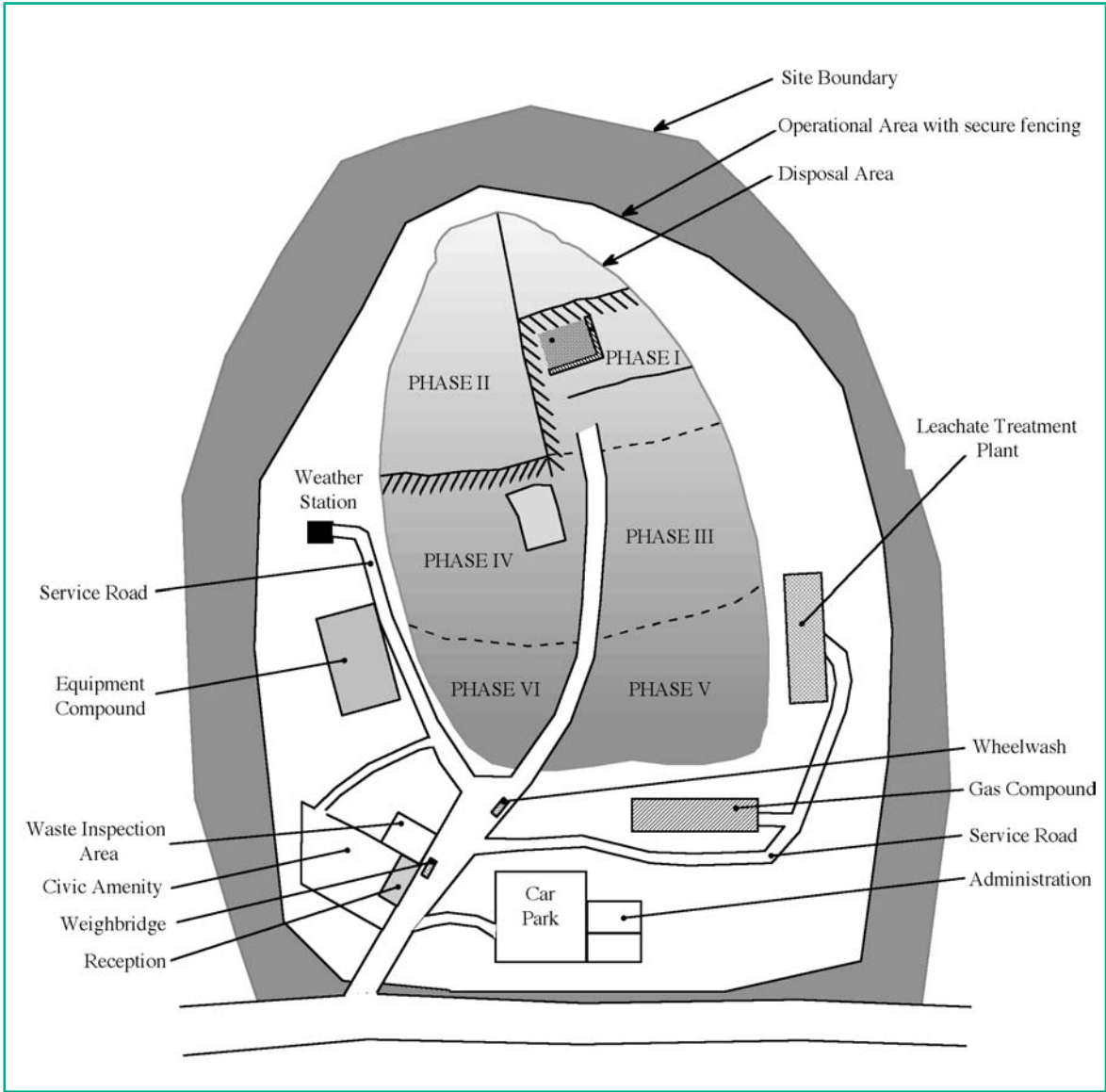

### 3.4 PHASING

The landfill should be developed in a series of phases. Phasing should allow progressive use of the landfill area so that construction, operation (filling) and restoration can occur simultaneously in different parts of the site. To avoid frequent (and disruptive) preparatory works it is recommended that the design lifespan of a phase be a minimum of 12 months.

Factors that need to be considered in determining the phasing are; waste intake which will determine the size and lifespan of the phase and the sequence of operation which must take into account the following:

- progressive construction, filling and restoration;
- forward planning to, in so far as possible ensure that subsequent phases are developed in the appropriate season;
- maximise use of on site materials and minimise double handling of material;
- installation of leachate and gas controls;
- management of the leachate collection system; and
- management of surface water run off.

A recommended phasing sequence is illustrated in Figure 3.2.

### 3.5 CELLS

Cells are sub-divisions of phases. The number of cells in a phase and cell size should be based on water balance calculations (Section 7.2.1). Consideration should be given to a combination of the factors discussed under 'phasing' and from constraints on vehicular maneuvering. Cells within a phase are separated by intercell bunds which are discussed in section 3.6. Minimising the cell size facilitates the landfilling operation through reducing leachate generation, minimising the area of exposed waste thereby reducing cover requirements, and assisting in the control of windblown litter. For each cell the designer should indicate estimated void space volume, active lifespan, and development sequence.

### 3.6 BUNDING

Bunds are generally used in landfill development for:

- perimeter screening;
- temporary screening; and
- boundary bunds - intercell bunds and phase boundaries.

Perimeter bunds are used for screening and to assist in the restriction of unauthorised access to the site. Their design should be consistent with existing topography. The height of the perimeter screen can vary from 2m to a height that screens the proposed development. Embankment slopes should be stable.

Temporary bunds can be used around the operational area for further screening and to assist in control of nuisances such as litter and noise. As the landfill development progresses the temporary bunding arrangement is moved along concurrently. Temporary bunds are generally around 2m height with side slopes of 1:2.5. These bunds may also act as a storage area for final/intermediate cover material.

Boundary bunds may be divisions between cells, within a phase, or separators between phases. Consideration needs to be given to the relationship between the bund, base liner and leachate collection system. Generally a bund of approximately 2m height located on the base of the facility will be used. It is normal practice for the primary liner to continue under the intercell bunding. Where a flexible membrane liner is used, a sacrificial layer can be placed over the bunds and then connected to the underlying liner. This provides a barrier between cells and prevents seepage of leachate into adjoining cells thus preventing contamination of surface water collected in cells prior to waste emplacement. Alternatively it may be possible to form the bund using the mineral sub-base and to lay the flexible membrane liner over same.

FIGURE 3.2: PHASING OF A LANDFILL DEVELOPMENT

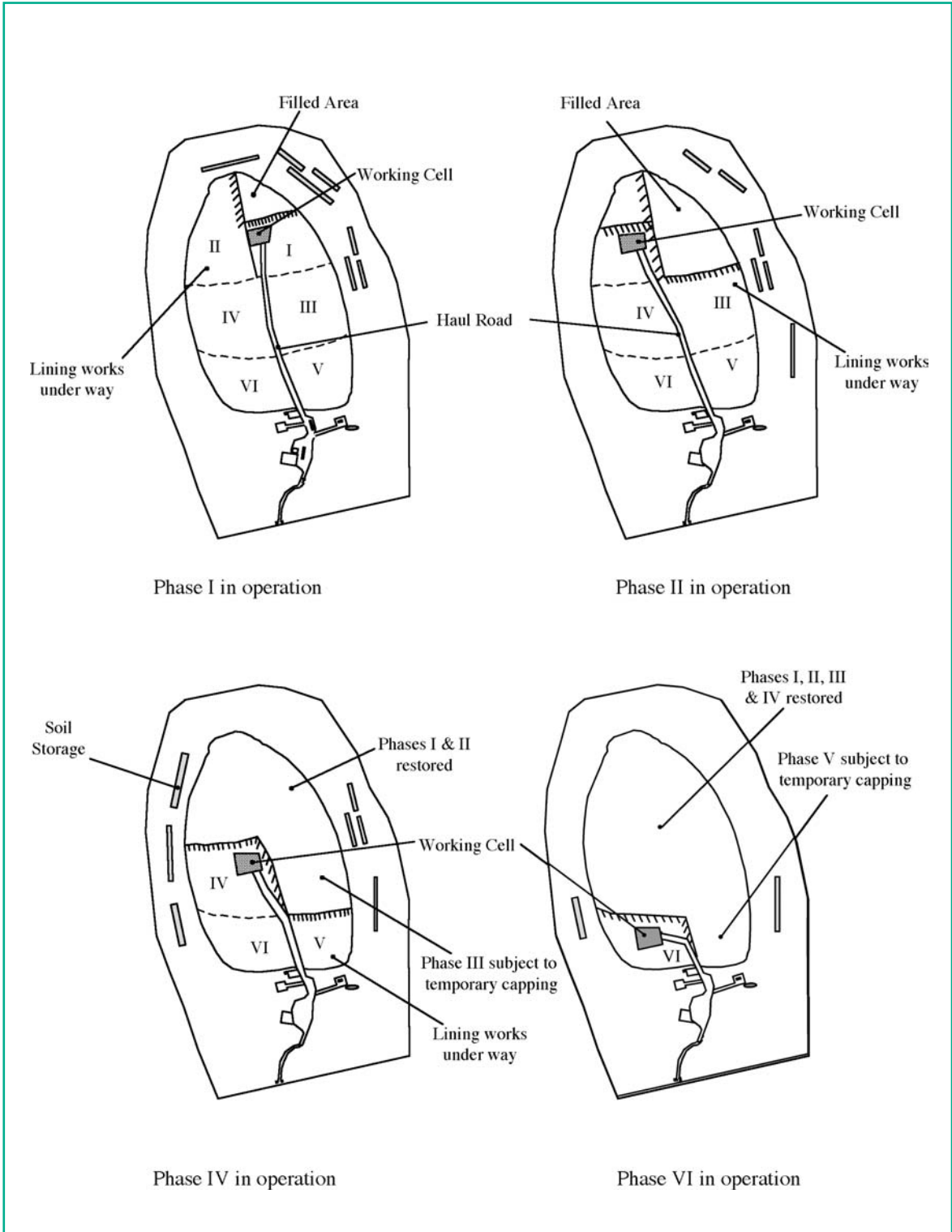



### 3.7 COVER MATERIAL

Cover material is an essential element of landfilling operations. In this section only that material for daily or intermediate cover is discussed. The capping system is discussed in Chapter 10. The daily/intermediate cover material assists in control of nuisances such as windblown litter, odour, vermin, flies and birds.

Daily cover (about 150mm if soil cover used) is the term used to describe material spread over deposited waste at the end of every working day. Daily cover should ideally be permeable to allow water to pass through thereby preventing ponding/perched water buildup. Intermediate cover refers to placement of material (minimum 300mm if soil used) for a period of time prior to restoration or prior to further disposal of waste. Intermediate cover should significantly reduce rainfall infiltration.

Details of cover material requirements should be provided under the heading of 'materials requirement and balance' as outlined in Section 3.3. The availability of on site material should be determined from investigations. The designer should identify borrow pit sources and stockpiling arrangement for cover material on site if required.

The designer should consider the use of alternative biodegradable materials for daily cover. These include:

- heavy duty reusable and biodegradable sheets;
- non reusable plastic films;
- geotextiles;
- foams and sprays;
- shredded wood/green grass; and
- compost.

Advantages of using alternative daily cover over traditional methods may include:

- preservation of void space;
- preservation of soil material;
- biodegradable; and
- permeable to water and gas.

### 3.8 LANDSCAPING

The landfill should present a clean and well managed appearance to the public. Provision of a buffer zone with landscaped berms and other tree planting may lessen the environmental impact. The development sequence should allow for early screening of the landfill and this may warrant construction and planting of screening bunds around the landfill perimeter at the beginning of the project.

The designer should take into account the proposed end use of the site after completion as this to some degree will dictate the final landform. This final landform should fit in with the surrounding environment.

Further guidance on site closure and restoration is provided in the Agency's manual on '*Landfill Restoration and Aftercare*'.

## 4. SITE INFRASTRUCTURE

### 4.1 INTRODUCTION

Site principal infrastructure elements are listed below and discussed in greater detail in the sections that follow. They are:

- access and traffic control;
- site accommodation and compounds;
- weighbridges;
- wheel cleaners;
- site services;
- civic waste facilities; and
- security.

### 4.2 ACCESS AND TRAFFIC CONTROL

In designing a landfill site consideration should have been given to access at the planning stage. Access can be by road, rail or water but in Ireland is typically by road.

In cases where access to the landfill site is to be by road then the impact of the proposed development on the existing road network should be examined. The results of a traffic analysis will determine if specific provisions are required to deal with the anticipated traffic flow. The existing road network may need upgrading to deal with the increase in traffic to the site or a dedicated road linking the nearest primary/secondary route to the proposed site may be required. In any case an analysis prior to detailed design should ensure that the potential for damaging existing road surfaces and the queuing of traffic on the public road are addressed.

The access road including the reception area should be paved to highway standard and should have a minimum width of 6m. Consideration should be given to the provision of passing points. Road design should be carried out in accordance with the National Roads Authority (NRA) *'Manual of Contract Documents for Roadworks'* - of which Volume 1 is the Specification for Roadworks.

Haul roads from the reception area to the entrance to each phase should be designed to a standard adequate to allow trafficking of heavy vehicles. Haul roads may need to accommodate the passage of heavy construction vehicles e.g. steel wheel compactors and tracked bulldozers.

Service roads to other facilities on site e.g. leachate treatment plant, gas extraction system, should be to an adequate standard to allow access by service vehicles.

Typical details for the access road, service road and haul roads are given in Figure 4.1. The materials required for road construction should be included in the materials balance requirements. The use of construction/demolition waste as a roadbase material should be considered. The use of geosynthetic reinforcement, eg geotextiles, may be required on weak or waste subgrades

Particular attention should be given to the access point to each cell. It is important that the access routes chosen do not put the liner at risk. Typical access ramps will be up to 6m in width and have slopes up to 10%. A schematic of a typical access ramp is shown in Figure 4.2.

Traffic signs within the landfill site should include stop signs and directional signs to reception, weighbridge, carpark and civic waste area etc. The designer is referred to DoE, *'Traffic Signs Manual, 1996'* for further guidance on signs. In addition to traffic signs provision should be made for the inclusion of a site sign at the site entrance. This should specify relevant details, opening hours, types of waste accepted, site licence number, contact numbers, etc.



FIGURE 4.1: SCHEMATIC OF TYPICAL ACCESS, SERVICE AND HAUL ROADS

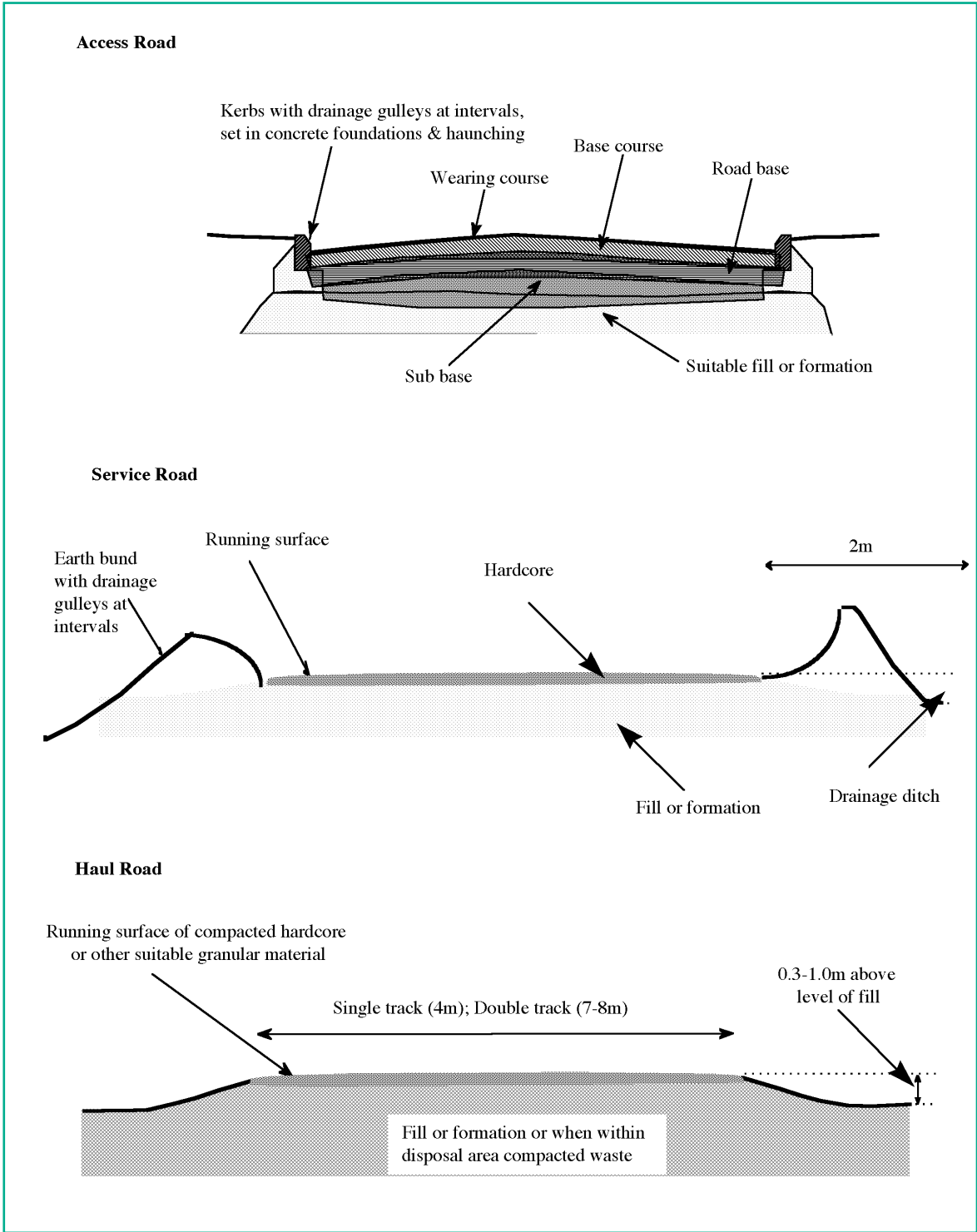
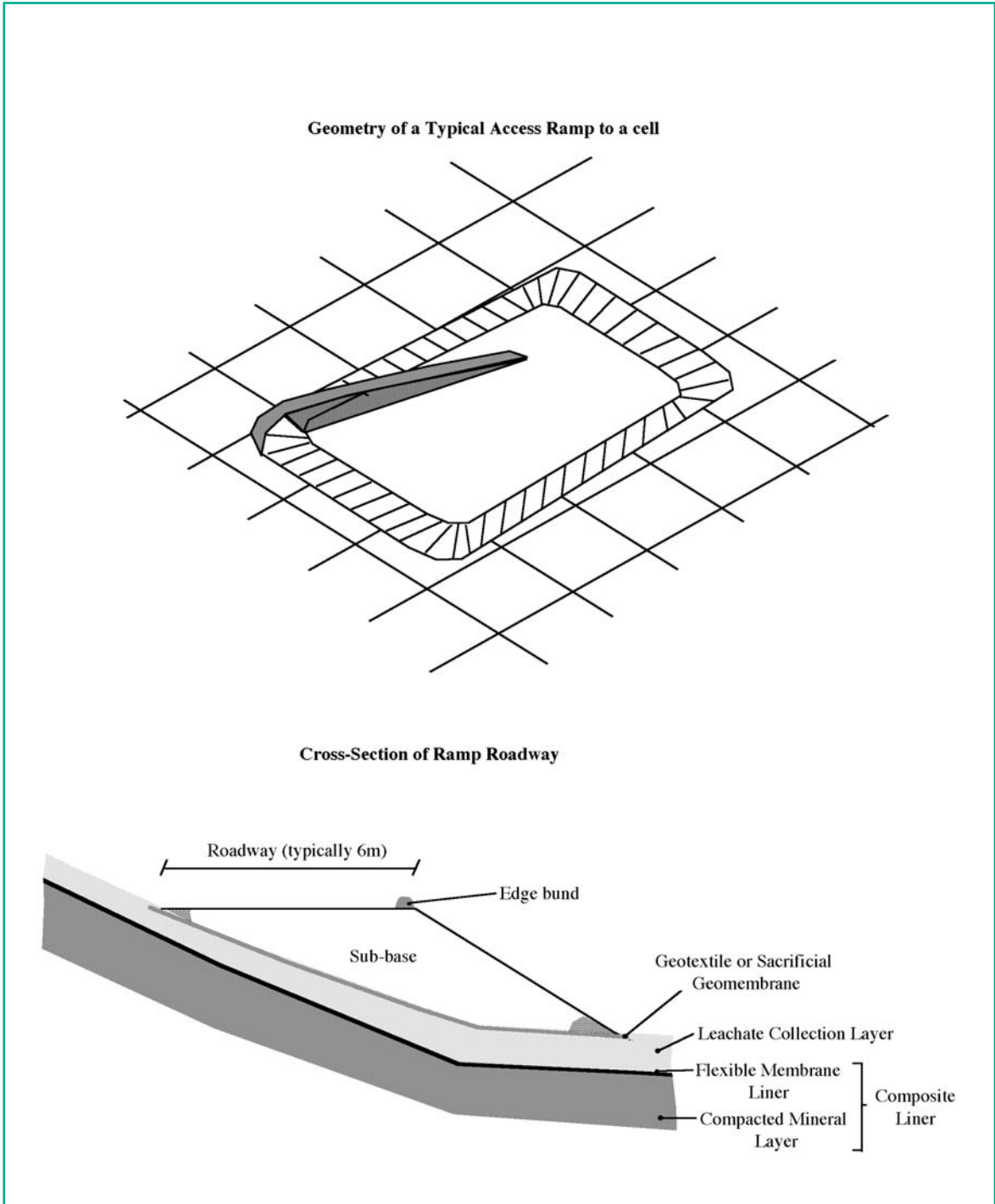

FIGURE 4.2: TYPICAL ACCESS RAMP



### 4.3 SITE ACCOMMODATION

Site accommodation must be designed, constructed and maintained to a high standard.

Site accommodation should include the following facilities:

- administration building consisting of an administration office, first aid area and general reception area;
- sanitary facilities: showers and toilets;
- staff facilities: lockers and mess room;
- waste reception area;
- monitoring equipment store;
- equipment maintenance and fuel storage; and
- parking area.

It is recommended that purpose built buildings be constructed. On-site laboratory facilities should be provided where necessary. The administration building should include a working telephone, a facsimile machine and should be suitable for the storage of records.

The waste reception area is an important part of the infrastructure of a landfill facility as it is used to determine whether a waste should be accepted for disposal to the site or not. The waste inspection facility should be located so as to cause minimum disturbance to other traffic using the landfill facility. It should be constructed on an impervious hardstanding area with retaining bunds. Drainage from this area should be independent of the rest of the reception area and should be discharged to the foul sewer or leachate treatment plant.

On site compounds are required for equipment maintenance and fuel storage. Fuel and oil should be stored in clearly marked and controlled areas. Tanks or containers for fuel and oil should be surrounded by a secure bund which is able to contain at least 110% of the capacity of the largest tank. Guidance on the construction and testing of bunds is given in Appendix A. The location and specification of fuel/oil tanks should be agreed with the County Fire Officer.

The parking area should provide sufficient parking spaces for staff and visitors. It should be located

adjacent to the administration building with easy access to reception and should not be accessible to traffic hauling waste to the landfill site.

### 4.4 WEIGHBRIDGES

A weighbridge is required for the accurate weighing of incoming waste. The weighbridge should be located adjacent to the waste reception area and sufficiently far enough away from the public road to avoid queuing onto the road. Weighing facilities should be adequate to accommodate the weighing of both incoming and outgoing traffic if necessary.

There are three general types of weighbridges; pitmounted, surface mounted and axle weighers. The advantages and disadvantages of each type are presented in Table 4.1. When selecting a weighbridge consideration will have to be given to:

- required length; and
- load capacity.

It is recommended the length of the weighbridge should be, at minimum, 15m with a minimum load bearing capacity of 60 tonnes. The cost of maintenance/calibration of a weighbridge may be significant.

It is normal practice for companies which provide weighbridges to supply and install the unit. The weighbridge is normally installed to a standard specification supplied by the weighbridge manufacturer. Foundations to receive the weighbridge must be constructed to the details supplied by the manufacturer and designer.

Suppliers of the weighbridge unit will also normally provide computerised software for recording details of the incoming waste. When selecting the computerised software, consideration should be given to the information to be provided to the Agency under the requirements of the waste licence.

TABLE 4.1: WEIGHBRIDGE TYPES:- ADVANTAGES/DISADVANTAGES

| Weighbridge type | Advantage  | Disadvantage   |
|------------------|--|--|
| Pit mounted      | No ramps required  | Difficult to relocate<br>Access required under weighbridge for maintenance |
| Surface mounted  | Easy to install<br>May be relocated<br>Reduced amount of engineering work required | Ramps required   |
| Axle weighers    | Low cost   | Not very accurate  |

#### 4.5 WHEEL CLEANER

A wheel cleaner is essential at a landfill site to prevent mud from being carried out onto the public road. There are various types of wheel cleaning units available (Figure 4.3). In general a shaker bar arrangement without the use of water or an arrangement with water or a combination of both is used. In addition to a wheel/chassis wash, consideration should be given to the provision of a full truck wash. At a minimum this would include a lance/steam cleaner.

Consideration should be given to employing a one way system through the wheel cleaner. The design of the wheel cleaning unit should ensure that there is a stable foundation below the unit and that the structure of the unit is capable of taking the weight of the trucks.

Where water is to be used as part of the wheel cleaner facility a water supply, drainage area and an area of hardstanding is required. Contaminated water should be discharged to an appropriate treatment system, eg foul sewer, leachate treatment plant, etc.

#### 4.6 SITE SERVICES

The design should include provision for the following services:

- lighting;
- telephone/fax;
- telemetry - continuous monitoring (CCTV) where required;
- water supply;

- fire water;
- wastewater (removal/treatment); and
- power supply.

Lighting should be provided in areas in operation after darkness. This should include the access from the public road to the site reception area and site facilities which may require maintenance outside normal working hours e.g. weighbridge, wheel cleaner, civic waste area etc.

A water supply is required for general on-site everyday purposes. In addition, there should be sufficient water storage for fire fighting. The chief fire officer of the relevant local authority should be consulted in relation to fire control at the facility.

#### 4.7 CIVIC WASTE FACILITIES

The principal function of a civic waste facility is to provide householders and commercial operators with a convenient centre to drop off recyclables and other wastes. It normally consists of a variety of containers designated for specific wastes and dedicated areas to allow for collection of wastes such as green waste, construction/demolition waste and bulky items. There is a growing tendency to develop civic waste sites as stand alone facilities but these facilities are also commonly incorporated as part of the infrastructure of a landfill.

A civic waste facility located on a landfill site should be accessible and capable of handling large traffic flows. The entrance and drive-in area should be paved. All collection containers should be placed on a paved surface. If waste intake is expected to be high consideration should be given to a split level arrangement, with skips on the lower level. Where provisions are made for the collection of batteries,

FIGURE 4.3: WHEELCLEANING ARRANGEMENTS

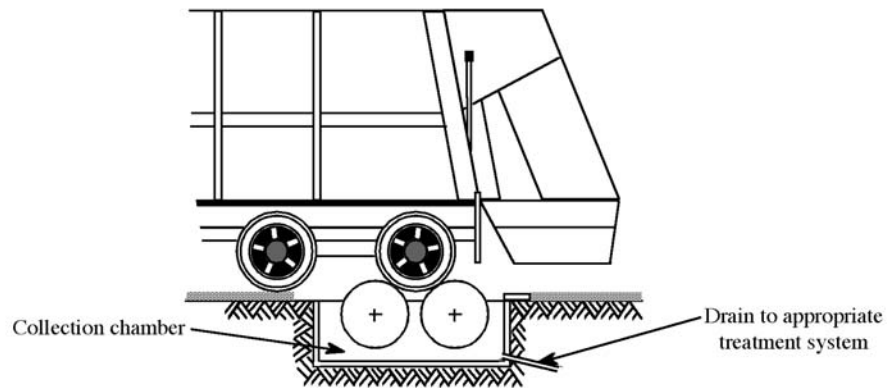
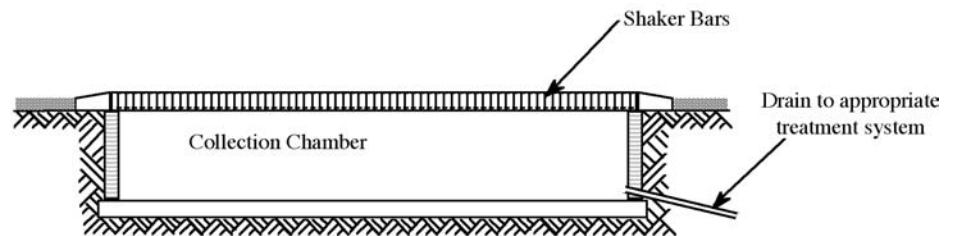
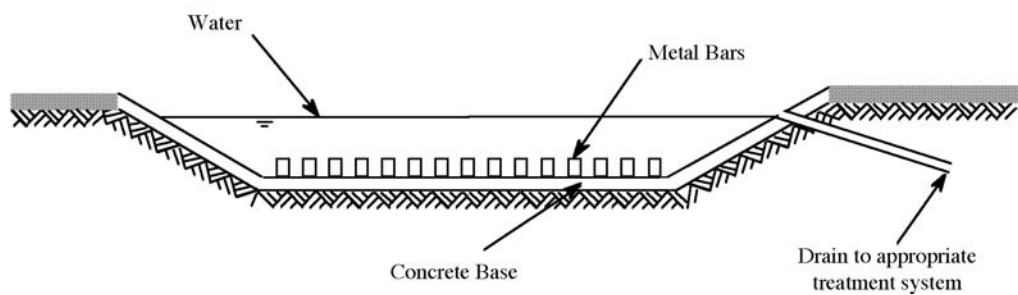
**Wheel Spinning Cleaning Unit****Shaker Bar Wheel Cleaner****Wheelwash Cleaner**

waste oils and similar materials the need for bunding should be considered.

Areas designated for storage, handling or treatment of green wastes or construction/demolition wastes should comprise of a hardstanding surface with an impervious base, peripheral bunding and access ramp. A sealed drainage system should be used to collect liquids emanating from these areas. Collected liquid should be diverted to leachate storage or treatment facilities.

Civic waste facilities may also be used as bring centres for household hazardous waste (HHW) and containers for their secure deposit should be provided. Examples of HHW are: used or out of date medicines and veterinary products; household detergents; paints and solvents; primary batteries; pesticides; and herbicides. Close supervision of HHW collection is required. Civic waste facilities should be manned at all times that they are open to the public.

Civic waste facilities should be landscaped so that they are aesthetically pleasing. A typical civic waste facility layout is presented in Figure 4.4.

#### **4.8 SECURITY**

The landfill design should incorporate security provisions which may include the following:

**Fencing :** Perimeter fencing should be provided at all sites. The fencing should be to an adequate standard (chainlink, palisade) and sufficient height (approximately 2.3m) to prevent unauthorised access.

**Gates :** Access gates should be provided at the reception area. It may be necessary to provide a number of gates at points around the site for access. All gates should be to a standard similar to that of the specification for the security fencing. The gates must be secured with suitable locks.

**Security cameras/alarms :** Security cameras may be used at the access point/reception area and at other strategic locations around the site e.g. civic waste area. Intruder alarms may be fitted to the reception facilities/compound stores and linked to a call out system.

FIGURE 4.4: TYPICAL CIVIC WASTE FACILITY LAYOUT

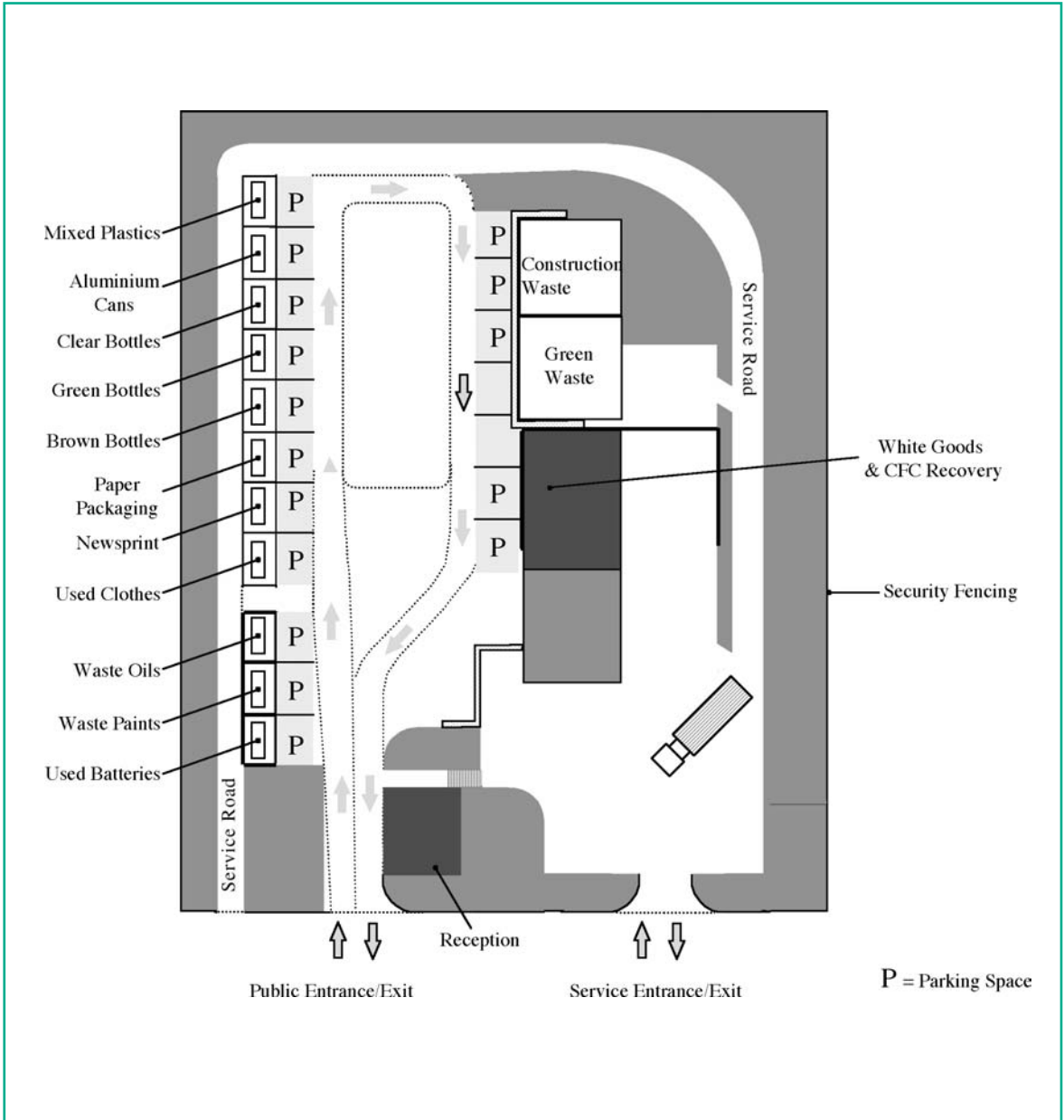



## 5. GROUNDWATER AND SURFACE WATER MANAGEMENT

### 5.1 INTRODUCTION

Groundwater and surface water are major natural resources of both ecological and economic value and their protection is of prime importance. It is therefore essential that a landfill design includes provisions for the management and protection of both these entities.

Information arising from the investigations will assist in detailing the level of groundwater/surface water management required. The sequence and extent of the investigation necessary is outlined in the Agency's Manual *'Investigations for Landfills'*.

### 5.2 GROUNDWATER MANAGEMENT

Groundwater management may be required to minimise/prevent:

- interference with the groundwater regime during the construction period;
- damage to the liner (by uplift);
- transport of contaminants from the landfill; and
- leachate generation by preventing groundwater infiltration.

#### 5.2.1 A STRATEGY FOR THE PROTECTION OF GROUNDWATER

A document outlining the national strategy for Groundwater Protection was published in 1999 entitled *'Groundwater Protection Schemes'*. One of the objectives of this document is to provide geological and hydrogeological information so that potentially polluting developments can be located in less vulnerable areas and identify appropriate measures to minimise the potential for pollution from these activities. The strategy works through the integration of two main components, land surface zoning and response matrices for potentially polluting activities. The land surface zoning takes account of groundwater sources, groundwater resources (aquifers) and vulnerability to contamination. When combined the outcome is a groundwater protection zone. The response matrices provide recommended responses to the location of the potentially polluting activities. These responses depend on the relative risk and describe the degree of

acceptability, measures to be used to minimise the pollution potential and investigation requirements, as appropriate.

#### 5.2.2 GROUNDWATER DIRECTIVE

The Waste Management Act of 1996, through the Waste Management (Licensing) Regulations, 1997 (SI No. 133 of 1997), and the Local Government (Water Pollution) Act, 1977 and subsequent amendments gives effect to *'Council Directive 80/68/EEC on the protection of groundwater against pollution caused by certain dangerous substances'*. The purpose of this Directive is to prevent the pollution of groundwater by substances belonging to the families and groups of substances in Lists I or II, and as far as possible to check or eliminate the consequence of pollution which has already occurred.

The Directive distinguishes between direct and indirect discharges into groundwater. A direct discharge of substances in the lists means an introduction of the substance to groundwater without percolation through the ground or subsoil. An indirect discharge means the introduction of the substances on the list to groundwater after percolation through the ground or subsoil.

It is important to note that this Directive prohibits direct discharge into groundwater of List I substances (exceptions are where a survey shows the groundwater is permanently unsuitable for any other use). Steps must be taken to prevent substances in List I and limit substances in List II from entering into the groundwater.

#### 5.2.3 GROUNDWATER CONTROL MEASURES

Information from the investigations should be used to assess whether groundwater control is required and if so what are the effects a control system will have on the groundwater. Information extracted from the investigations should include:

- groundwater regime;
- permeability and transmissivity of all strata;
- distribution, thickness and depth of subsoils and bedrock;



- attenuation properties of the subsoil;
- location of wells, springs, sink and swallow holes or other groundwater features;
- groundwater contours, gradients, rates of flow, and direction of flow;
- groundwater quality, (chemistry, and natural problems);
- groundwater protection zones;
- groundwater abstractions rates;
- predicted influence of short/long term dewatering;
- relationship with surface waters;
- catchment boundaries;
- groundwater vulnerability; and
- aquifer category.

Maps should be provided to display the foregoing information. The identification of potentially water bearing or low permeability strata and location of the water table or piezometric level in relation to the proposed excavation is the starting point for any assessment of groundwater control needs. This will generally involve the study of borehole and trial pit logs and groundwater level records from boreholes and piezometers.

The location of the landfill liner system in relation to the water table will dictate the control measures required. If the liner system is located above the water table so there is an unsaturated zone immediately below the waste the likelihood is that no groundwater control measures will be required. On the other hand if there is a relatively high water table and the liner system is located below this level groundwater control measures may be required.

Examples of groundwater conditions that may occur are presented in Figure 5.1. Illustrated are the cases of:

- Outward gradient;
- Inward gradient;
- Perched groundwater; and
- Confined aquifer.

Groundwater control can be achieved by physical exclusion or by pumping from sumps and wells. Physical exclusion control methods may include provision for an under drainage system, peripheral drains or cut-off walls. Pumping should only be undertaken if short term control is required. An example of a typical cut off drain is given in Figure 5.2. Approximate ranges of application of groundwater control techniques in soils are given in Appendix B, Figure B.1. Appendix B.1 provides a list of methods for groundwater control. Further information on groundwater control may be obtained from CIRIA Report No.113 (CIRIA, 1988). This report will shortly be superseded by CIRIA Report titled '*Groundwater Control: design and practice*'.

Where groundwater control measures are required, the subsequent outlet for the groundwater should be established. This may be directly to a water body or to a retention pond if the groundwater does not meet the water quality standards of the receiving waters.

FIGURE 5.1: GROUNDWATER CONDITIONS

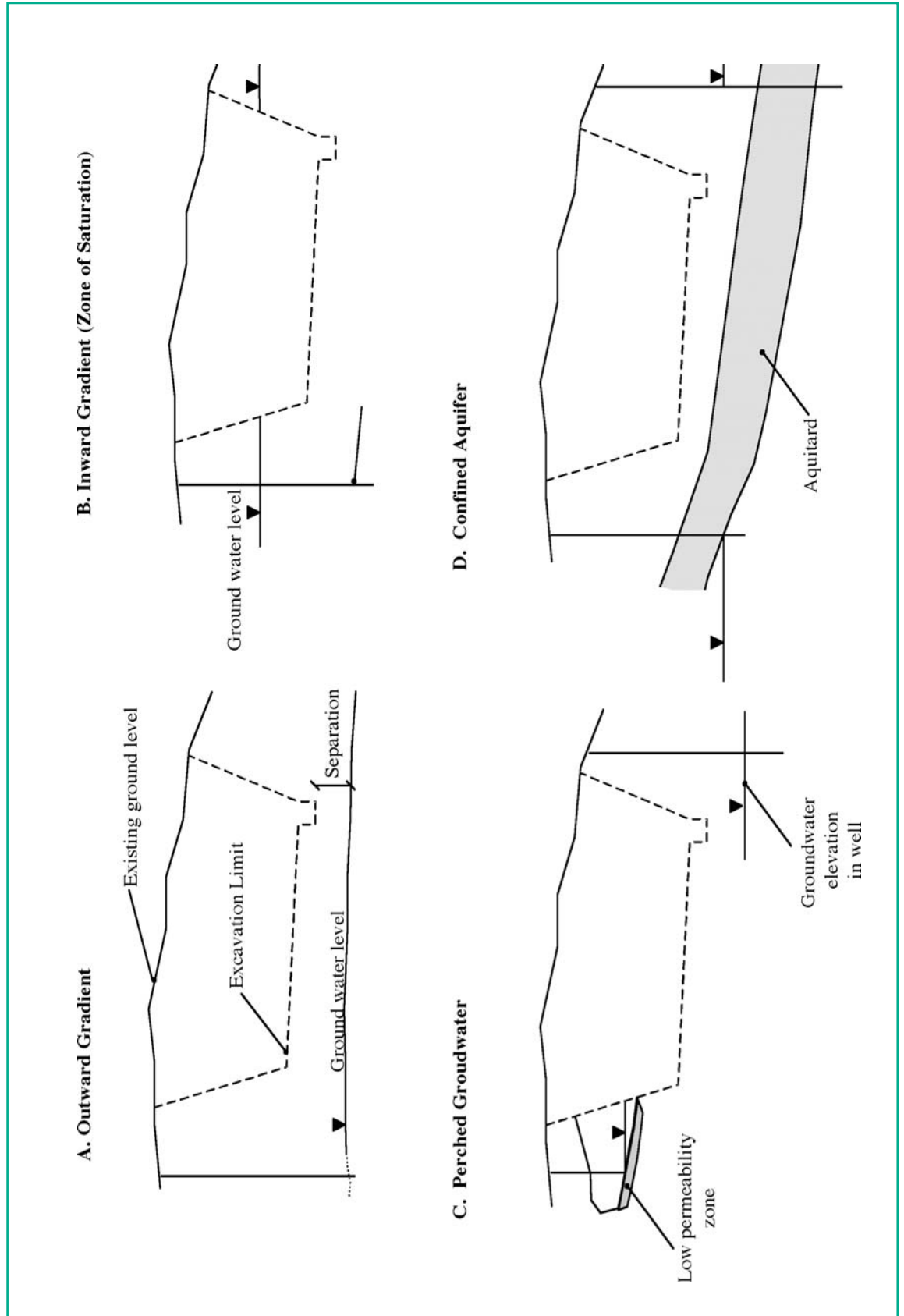
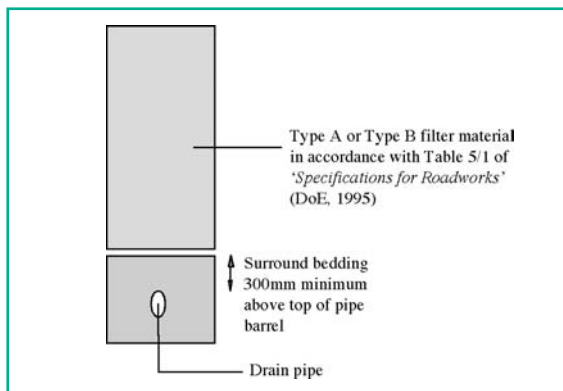

FIGURE 5.2: TYPICAL CUT OFF DRAIN



### 5.3 SURFACE WATER MANAGEMENT

Surface water management is required to minimise:

- leachate generation by preventing ponding and the infiltration of water into the fill;
- transport of contaminants from the landfill; and
- erosion of the liner, solid waste or cover material.

These can be achieved through the provision of surface water collection systems.

#### 5.3.1 SURFACE WATER COLLECTION SYSTEM

Surface water collection systems need to be provided at all landfills. Information required from the investigation stage to assess the affect that a proposed surface water control system would have on the surrounding environment includes:

- status of surface water;
- surface water drainage patterns;
- details of onsite ponding and streams;
- flow regime in the surface water;
- water quality;
- temporal variations in flow and quality;
- abstractions;
- background surface water quality; and
- possibility of flooding

Information collected on water levels and flows may be used to model and determine return periods and levels of floods at the design stage.

#### Surface water drainage

The surface water drainage system performs the function of collecting and transporting run off from the landfill and surrounding area to drains at the periphery of the landfill. Drainage channels should be located so that surface water run off from the surrounding area is intercepted and diverted before it reaches the waste. Perimeter surface water control systems are usually designed to accommodate both off site run off and onsite run off.

The off site run off in free draining soils may drain to the groundwater and may be collected by a groundwater control system. In fine grained soils the surface water may not drain as easily and it may be necessary to provide a surface water control system. Surface water can be controlled using drainage blankets, ditches, french drains and garland drains, as shown schematically in Figure 5.3.

Surface water run off arising within the landfill area may be classified as that from:

- cells under construction;
- operational areas; and
- restored areas.

It may be necessary to provide a settlement pond to remove solids from surface water from cells under construction or from surface water running off restored areas. Alternatively, the surface water from these areas may be released directly to a water body, provided they meet the receiving water standards.

Water from cells under construction may need to be pumped to the drainage channels or retention pond. Surface water from the restored areas should be transported via drainage layers incorporated in the capping system (Section 10.4.2) to the perimeter drainage channels. Surface waters in active cells should be directed into the leachate collection system.

Surface water run off from paved areas and site access roads may be directed to storm water retention ponds or if necessary to leachate storage facilities. Provision should be made for surface water from parking/fueling/repair/maintenance/paved areas to pass through petrol/oil interceptors.

### Surface Water System Design

The design of surface water drains is usually based on storm events with specified return period and duration of rainfall. Common return periods for design purposes are 1, 5, 10, 25 and 50 years. The return period may be selected based on site characteristics, the risk of failure and the consequences of failure of the drainage system. It should be noted that longer return periods will lead to systems with greater capacities but at a higher cost.

The peak discharge rate and run off volume during peak discharge should be determined. Design methods used include:

- Rational Method;
- Modified Rational Method; and
- TRL (Transport Research Laboratory) Hydrograph Method.

The surface water management systems should be designed to collect and control at least the water volume resulting from a specified duration and return period.

Rainfall intensity may be calculated based on time of concentration and return period. Values for specific durations and return periods for various parts of Ireland can be obtained from the Meteorological Office in Dublin or may be read from charts and tables from JJ Logue, *'Extreme Rainfalls in Ireland'*.

The Flood Studies Report (FSR) may also be used for predicting flows. The FSR contains studies on flow predictions for small catchments (Small Catchment Theory). The application of small catchment theory may be relevant as the examination of a landfill and its catchment is usually a localised study.

### Channels and drains

Surface water drains can take the form of piped systems or open channels:

#### *Piped Systems*

Design tables based on the Colebrook White Formula are usually used in the design of piped drain systems. The selected pipe diameter should be capable of conveying the peak flow discharged. The groundwater cut off drain shown in Figure 5.2 is similar to a surface water piped drain.

Groundwater/surface water drains are typically 300-400mm, precast concrete. The pipe bedding and

surround material is critical. Bedding/laying/surround should be carried out to a standard similar to that of DoE, *'Specifications for Roadwork's, 1995'*. The bedding material is typically granular material with 95-100% passing a 20mm size sieve. When pipe drains are used consideration should be given to access for maintenance and inspection.

#### *Open Channels*

Open channel diversion ditches are usually sized based on the Manning's Formula:

$$Q = (1.49AR^{2/3}S^{1/2})/n$$

where:

Q = discharge (m<sup>3</sup>/s)

1.49 = factor to convert from imperial units to standard metric units

A = cross sectional area of channel (m<sup>2</sup>)

R = hydraulic radius of the channel (m)

S = longitudinal slope of the channel (m/m)

n = coefficient of roughness

Values for n for various channels and for maximum permissible velocity values for various types of channel lining can be found in textbooks. Channels are generally wide and shallow with trapezoidal, triangular, or parabolic cross sections. Side slopes of channels should generally be no greater than 2.5H:1V although steeper slopes may be achieved if suitable erosion protection measures are adopted or if ditches are lined with concrete. To minimise erosion open channels may be lined with vegetation or may be rip-rapped. Open channels can be lined with a geosynthetic or natural material.

### Receiving Waters

To prevent erosion it may be necessary to provide non erodible material at the base of the channel bed of the receiving water. This typically may consist of some type of rip rap design. Materials such as geotextile membranes, gabion baskets, stone mats can be used.

### Retention Ponds

Retention facilities may be required for sediment control of surface water. These facilities may consist of:

- concrete tanks designed to BS8007;
- prefabricated units; and
- geosynthetic lined, e.g. PVC lined facilities.

Retention facilities should be designed to prevent overtopping resulting from run off. As with surface water drainage systems, the return period may be selected based on site characteristics, the risk of failure and the consequences of failure of the system. A minimum freeboard of 0.5m should be included to prevent overtopping.

Sand size particles can usually be removed by passing the discharge through a grit trap or settlement tank. Such tanks typically have a minimum size of 3 by 1.5m, are approximately 1.5m deep and are designed on the basis of particle settlement velocities. The sand will collect at the base of the tank and will need to be removed periodically to ensure the tank continues to operate efficiently. Silt and clay particles may require lagoons in order to settle.

#### **5.4 GROUNDWATER / SURFACE WATER MONITORING POINTS**

The location of monitoring points for surface water and groundwater should have been determined during the investigation stage. However, the need for additional monitoring points may become apparent during the design and operation of the landfill.

FIGURE 5.3: METHODS FOR SURFACE WATER CONTROL

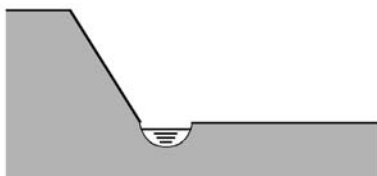

**Ditch:** Ditches are usually only a viable option in stable ground such as rock or stiff clay. Occasionally a lining is used to control erosion

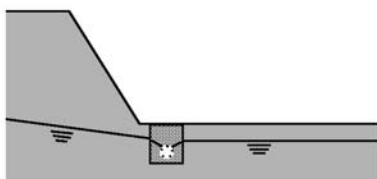

**French Drain:** This consists of a gravel-filled trench typically 0.5m wide by 0.5m (or more) deep with a perforated pipe to collect and transmit the flow. Lining the trench with a geotextile filter membrane before placing the gravel and pipe is a useful method for controlling migration of fine soil particles.

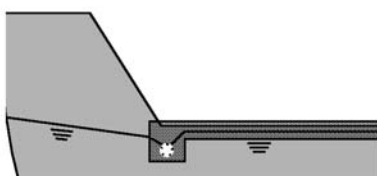

**Drainage Blanket:** This consists of a layer, 150mm to 300mm thick, of free-draining material such as gravel laid on the base of an excavation to collect vertical seepage. The use of a geotextile filter membrane below the drainage blanket is a useful method for controlling migration of fine soil particles. For large areas a network or herringbone of perforated drainage pipes may be needed to transmit the flow.

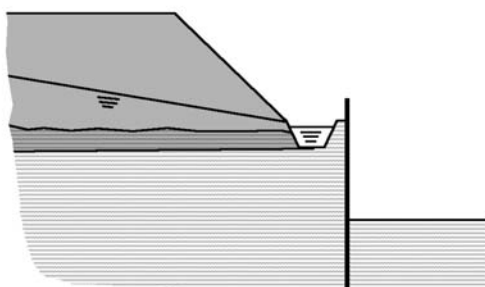

**Garland Drains:** Where water enters an excavation as overbleed above an impermeable layer, a garland drain can be used above the base of the excavation to intercept this inflow. Depending on circumstances and soil conditions, garland drains may be channels, ditches or french drains.

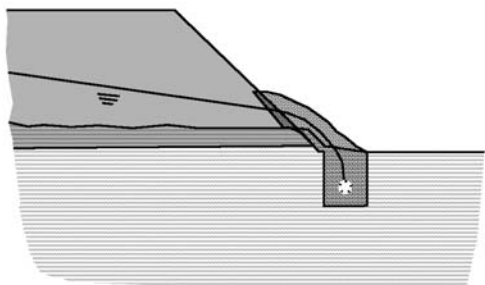

**Batter Protection:** Where there is a risk of seepage flows emerging on an excavation slope, protection is required to prevent erosion or slope failure. This can be provided by a gravel berm or sandbags.

## 6. LINING SYSTEMS

### 6.1 FUNCTIONS OF A LINING SYSTEM

The lining system protects the surrounding environment including soil, groundwater and surface water by containing leachate generated within the landfill, controlling ingress of groundwater, and assisting in the control of the migration of landfill gas. The selected liner system must achieve consistent performance and be compatible with the expected leachate for the design life of the facility.

### 6.2 REQUIREMENTS OF LINER SYSTEMS

The following sections lists options for liner systems for non-hazardous, hazardous and inert landfills. Figure 6.1 illustrates the minimum requirements for each landfill type. Details on the protective layer shown in Figure 6.1 are given in Section 6.6.3. A brief description of materials that may be used as components of a lining system are given in Sections 6.3 to 6.6. Details on leachate collection systems and drainage requirements are discussed in Section 7.3.

#### 6.2.1 HAZARDOUS WASTE LANDFILL

At minimum a composite liner should be used for hazardous waste landfill facilities. Two options are presented that may be used. The option to be used is dependent on the nature of the waste materials being deposited. Alternative systems may be considered for pre-treated hazardous wastes, eg solidification, stabilisation and vitrification of hazardous wastes.

#### Option 1: Single Composite Liner

The liner system should consist of the following:

- a minimum 0.5m thick leachate collection layer having a minimum hydraulic conductivity of  $1 \times 10^{-3} \text{m/s}$ ;
- the upper component of the composite liner must consist of a flexible membrane liner. At minimum a 2mm HDPE or equivalent flexible membrane liner should be used, as it is sufficiently robust but at the same time not prone to excessive cracking and construction difficulties;
- base and side wall mineral layer of minimum thickness 5m having a hydraulic conductivity less than or equal to  $1 \times 10^{-9} \text{m/s}$ ; and

- a minimum 1.5m of the 5m thick mineral layer should form the lower component of the composite liner and should be constructed in a series of compacted lifts no thicker than 250mm when compacted.

#### Option 2: Double Composite Liner

This system has two composite liners on top of each other with a leachate detection system between each layer. It should consist of the following:

- a minimum 0.5m leachate collection layer having a minimum hydraulic conductivity of  $1 \times 10^{-3} \text{m/s}$ ;
- top composite liner consisting of at minimum:
  - a minimum 2mm HDPE or equivalent flexible membrane liner; and
  - a 1m thick layer of compacted soil with a hydraulic conductivity less than or equal to  $1 \times 10^{-9} \text{m/s}$  constructed in a series of compacted lifts no thicker than 250mm when compacted or a 0.5m artificial layer of enhanced soil or similar giving equivalent protection to the foregoing also constructed in a series of compacted lifts no thicker than 250mm when compacted;
- a minimum 0.5m thick leachate detection layer having a minimum hydraulic conductivity of  $1 \times 10^{-3} \text{m/s}$  or a geosynthetic material that provides equivalent performance; and
- bottom composite liner consisting of at minimum:
  - a minimum 2mm HDPE or equivalent flexible membrane liner upper component;
  - base and side wall mineral layer of minimum thickness 4m having a hydraulic conductivity less than or equal to  $1 \times 10^{-9} \text{m/s}$ ; and
  - a minimum 1m of the 4m thick mineral layer should form the lower component of the composite liner and should be constructed in a series of compacted lifts no thicker than 250mm when compacted.



### 6.2.2 NON-HAZARDOUS BIODEGRADABLE WASTE LANDFILL

For all non hazardous waste landfills at minimum a composite liner system should be used.

The liner system should at minimum consist of the following components:

- a minimum 0.5m thick leachate collection layer having a minimum hydraulic conductivity of  $1 \times 10^{-3} \text{m/s}$ ;
- the upper component of the composite liner must consist of a flexible membrane liner. At minimum a 2mm HDPE or equivalent flexible membrane liner should be used; and
- the lower component of the composite liner must consist of a 1m layer of compacted soil with a hydraulic conductivity of less than or equal to  $1 \times 10^{-9} \text{m/s}$  constructed in a series of compacted lifts no thicker than 250mm when compacted or a 0.5m artificial layer of enhanced soil or similar giving equivalent protection to the foregoing also constructed in a series of compacted lifts no thicker than 250mm when compacted.

### 6.2.3 INERT WASTE LANDFILL

The liner system for an inert landfill should at minimum meet the following requirements:

- base and side wall mineral layer of minimum thickness 1m with a hydraulic conductivity less than or equal to  $1 \times 10^{-7} \text{m/s}$  or a 0.5m artificial layer of enhanced soil or similar giving equivalent protection to the foregoing.



FIGURE 6.1(A): LINING SYSTEMS FOR HAZARDOUS WASTE LANDFILLS

**Hazardous Waste Landfill**

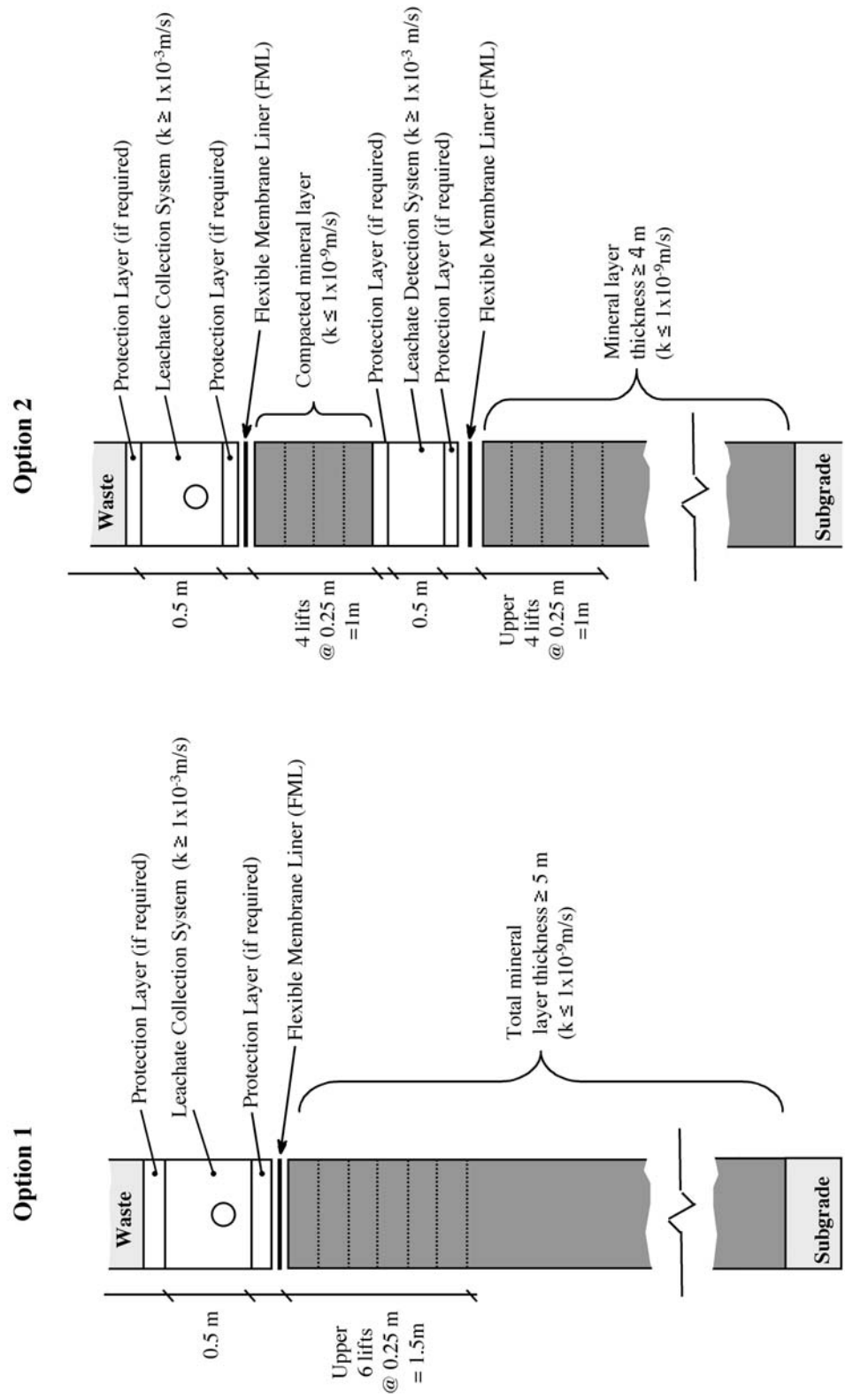
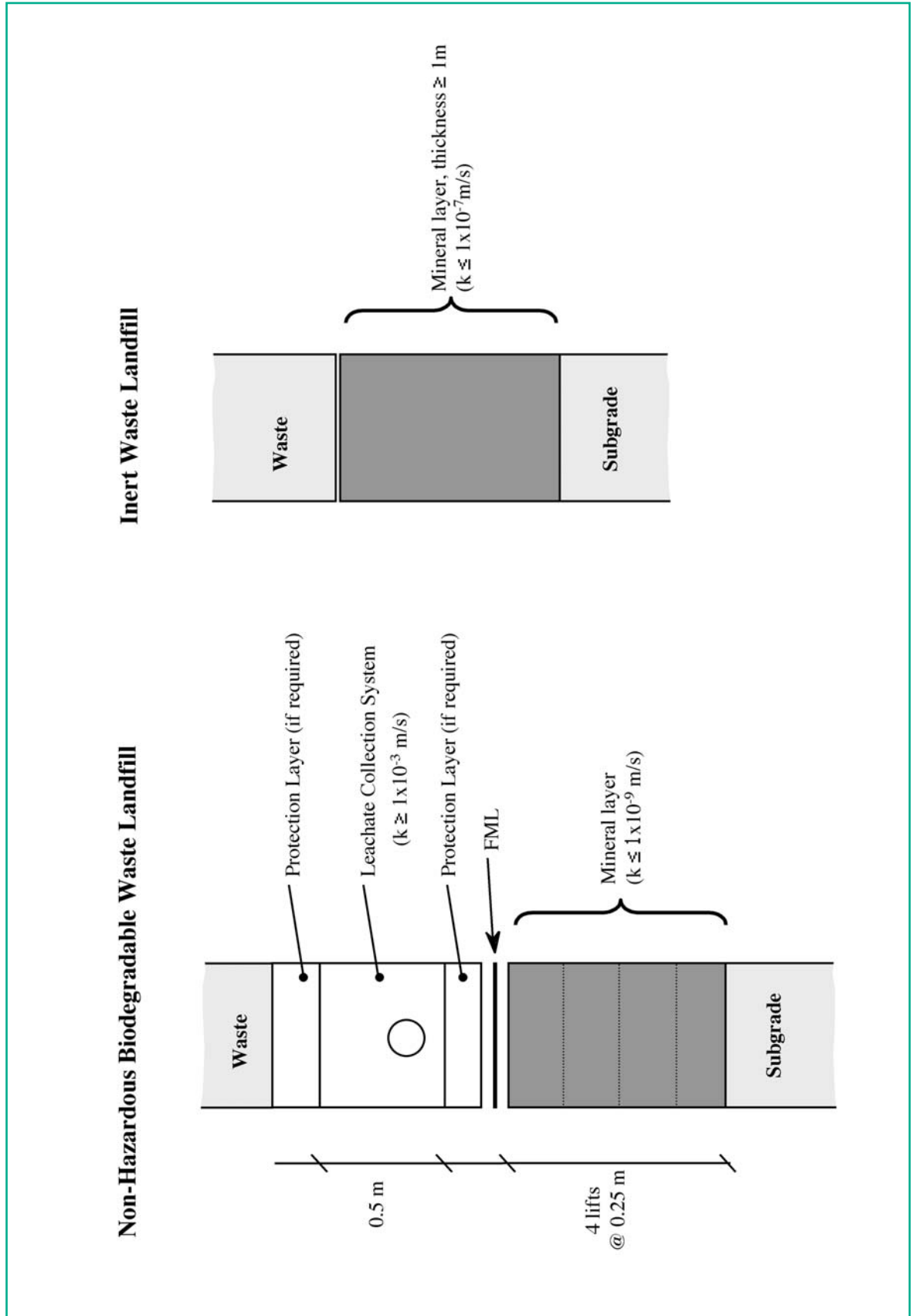

FIGURE 6.1(B): LINING SYSTEMS FOR NON-HAZARDOUS WASTE AND INERT WASTE LANDFILLS



### 6.3 NATURAL CLAY

Natural clays of low hydraulic conductivity, such as clays, silty clays and clayey silts, have the potential to make good liners. The continuity and hydraulic conductivity of *in situ* natural liner materials are difficult to predict and expensive to prove and for this reason engineered liners are recommended.

It is usual where suitable material of low permeability is found on site for upper layers to be excavated and reworked to a specification. When suitable material is found locally the material is also reworked on site. The thickness and hydraulic conductivity of the clay layers will depend on landfill type, recommendations are given in Section 6.2.

#### 6.3.1 DESIGN PARAMETERS

Parameters that influence the hydraulic conductivity and are of concern in the design include:

- clay content;
- particle size distribution;
- degree of compaction (density);
- compaction method; and
- moisture content.

The natural characteristics of the material; clay content; grain size and content, cannot be changed. The degree of compaction and the moisture content of the material effect the hydraulic conductivity but can be altered when the material is reworked. A low hydraulic conductivity is easiest to achieve when the soil is compacted wet of optimum moisture content which is achieved at maximum dry density. Figure 6.2 illustrates the relationship between density, hydraulic conductivity and moisture content. The minimum hydraulic conductivity value can occur anywhere in the range of 1 to 7% wet of optimum moisture content.

It is important to be aware that too dry a soil may result in a high hydraulic conductivity while too wet a soil may possibly have too low a strength with a greater shrinkage potential. Where there is a possibility of shrinkage it may be necessary to resort to compacting the material slightly dry of its optimum moisture content but to a higher density using a much higher compactive effort.

Appendix C provides a list of tests that may be used to assess the suitability of a clay liner.

#### 6.3.2 SOIL CLASSIFICATION TESTS

The suitability of the clay material as a component for the liner system should be assessed from soil classification tests. Properties outlined in Table 6.1 should at minimum be identified. Typical ranges for a number of properties of clays that are considered suitable for its use are given in Table 6.2.

#### 6.3.3 STRESS DEFORMATION BEHAVIOUR

Calculations for stability require an assessment of the deformation behaviour and swelling characteristics of the mineral material. The compressibility, swelling behaviour and shear strength should be determined in accordance with BS 1377 from test specimens prepared in the laboratory at the relevant placement densities and moisture content or from samples taken from a trial pad.

#### 6.3.4 HYDRAULIC CONDUCTIVITY

The hydraulic conductivity (K) or coefficient of permeability is a function of the porous medium and also of the fluid. It is sometimes confused with specific or intrinsic permeability (k) which is a property of the medium (solid component) only. Soils with a small hydraulic conductivity are generally referred to as low permeability soils.

Hydraulic conductivity can be examined in the laboratory by performing tests on undisturbed field samples or laboratory prepared test specimens. Important factors that influence laboratory hydraulic conductivity include sample characteristics and preparation, permeant properties, design of the test apparatus, and selection and control of variables during test performance. These factors may (and are likely to) result in differences between the laboratory and field measured hydraulic conductivities. It is recommended that laboratory measurements are carried out to investigate the suitability of soil as a liner material prior to construction of the liner. The hydraulic conductivities obtained from the laboratory can be used to specify an acceptable range for moisture content and density.

Laboratory hydraulic conductivity testing of samples from the constructed liner is restricted because of the length of time required for a test. Where cores are taken from the liner under construction for laboratory testing the core hole should be backfilled

with bentonite or similar material. The triaxial compression test (BS: 1377 : Part 6 : 1990) is normally used to estimate laboratory hydraulic conductivity. The effective confining stress utilised in the hydraulic conductivity test should not be excessive as this may produce an artificially low hydraulic conductivity. The maximum effective confining stress should be prescribed in the quality assurance plan. In the absence of a specified value, a value of 35kPa has been recommended for both liner and cover system (*USEPA, 1993, Technical Guidance Document, Quality Assurance and Quality Control for Waste Containment Facilities*).

*In situ* hydraulic conductivity tests are not usually performed on the completed liner because of the duration of the test. *In situ* tests however may be performed on a trial pad. There are four *in situ* tests methods generally used: borehole test, porous probes, infiltrometer tests, and underdrain tests. The sealed double ring infiltrometer method is considered most successful. Further information on these methods can be obtained in a review of field hydraulic conductivity's by Daniel's 1989.

It may be necessary to assess permeability behaviour of the material using a pH stabilised leachate, similar to that expected to be produced at the proposed landfill, or using a specially fabricated test liquid as described in the '*Geotechnics of Landfill Design and Remedial Works Technical Recommendations - GLR, 1993*' and given below:

- 5% inorganic acid (hydrochloric, nitric and sulphuric acids, each 33 vol%), pH 1;
- 5% organic acid (acetic and propionic acid, each 50 vol%), pH 2.2;
- metal salt leachate (nickel chloride, copper chloride, chromium chloride, zinc chloride, each 1g/l), pH 2.9; and
- synthetic leachate (0.15ml sodium acetate, 0.15ml acetic acid, 0.05ml glycine, 0.007ml salicylic acid), pH ~4.5.

### 6.3.5 CONSTRUCTION PROCESS

*In situ* and laboratory testing should be performed to assess suitability of material prior to, during and after construction.

### Processing prior to placement

The soil may need to be processed to bring it to a condition suitable for use in the liner system. If the material consists of large clods they need to be broken down by suitable machinery, e.g. discs or rototillers, with removal of stones and rocks, e.g. by large screens and by hand. The moisture content of the soil may need to be adjusted to achieve a moisture content slightly higher than optimum. This may be accomplished by spreading the soil in thin layers and wetting or drying the soil uniformly as the case may be.

### Surface preparation and soil placement criteria

The minimum recommended thick soil component (see Section 6.2) should be constructed in a series of compacted lifts. The lift thickness is dependent on the soil characteristics, compaction equipment, firmness of the foundation materials, and the anticipated effort needed to achieve the required soil hydraulic conductivity.

The soil should be placed in lifts no thicker than 250mm when compacted. Compaction of the material should be carried out using suitable equipment such as a sheepsfoot roller or drum roller which should be selected after field trials. A number of passes of the equipment over a given lift of soil ensures that the liner has been compacted properly. The type of compaction equipment and the number of passes of the equipment over a given lift should be decided based on field trials. These should meet the criteria of the design specification e.g. percentage compaction, the range of moisture contents and the hydraulic conductivity required and become the basis for the working method.

Lifts of soil must be bonded together to avoid highly permeable zones, so the surface of a previously compacted lift should be rough to attain this bond. Care should be taken during dry weather to ensure that desiccation cracking does not occur in the clay liner. In such cases regular spraying of the surface may be required. The surface of the final lift should be smooth when overlain by a flexible membrane liner.

Important criteria for placement are density and moisture content. The density achievable as a function of the moisture content should be determined by laboratory compaction tests (Proctor Test) in accordance with BS 1377 : Part 4 : 1990.

FIGURE 6.2: EFFECT OF MOISTURE CONTENT AND COMPACTIVE ENERGY ON HYDRAULIC CONDUCTIVITY FOR A SILTY CLAY (AFTER MITCHELL, HOOPER AND CAMPANELLA, 1965)

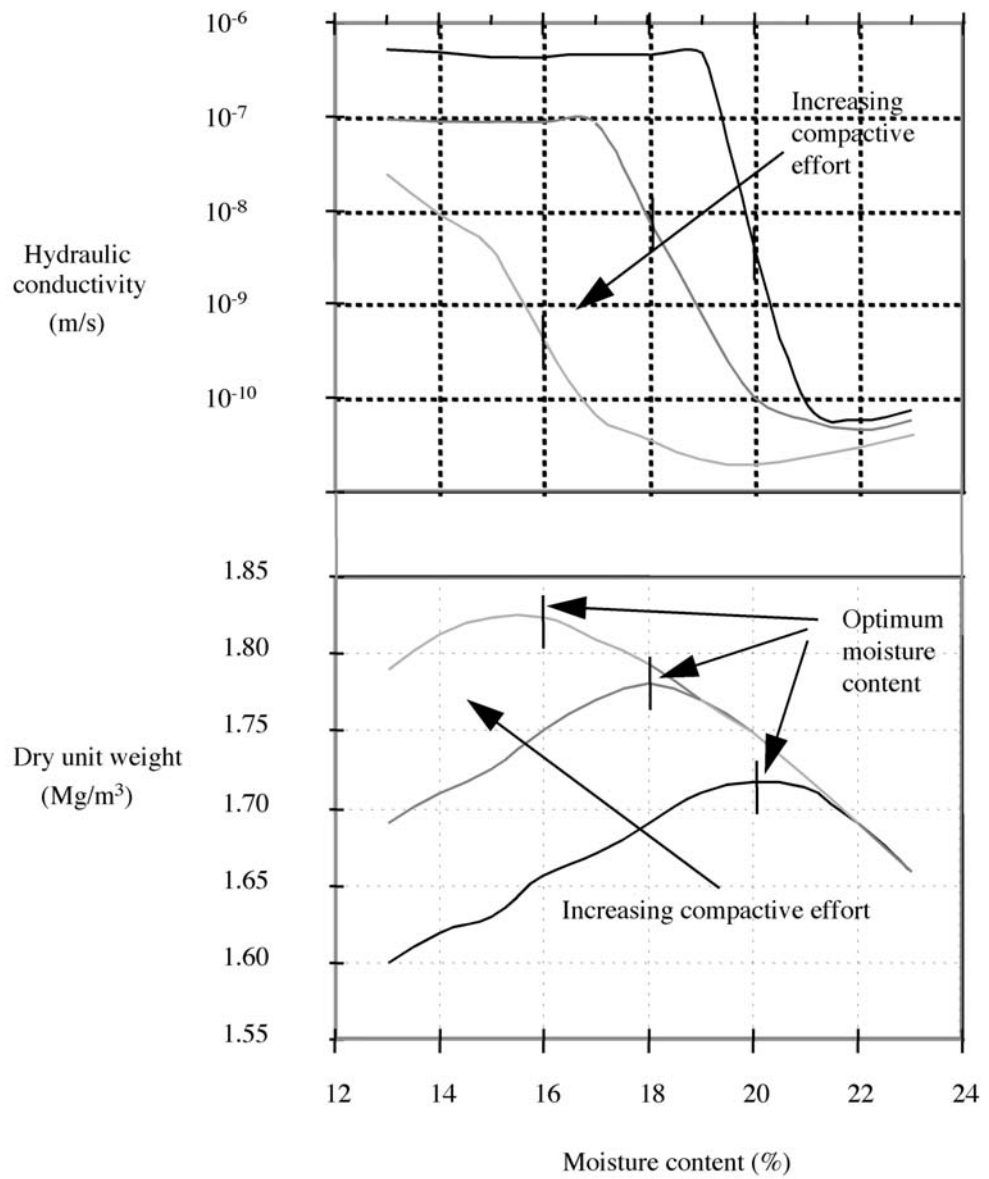

TABLE 6.1: SOIL CLASSIFICATION TESTS

| Test   | Standard                              |
|--|---------------------------------------|
| Moisture content   | BS 1377 : Part 2, Section 3 : 1990    |
| Atterberg limits (liquid limit, plastic limit, plasticity index) | BS 1377 : Part 2, Sections 4, 5: 1990 |
| Particle density (specific gravity)                              | BS 1377 : Part 2, Section 8 : 1990    |
| Particle size distribution                                       | BS 1377 : Part 2, Section 9 : 1990    |
| Maximum dry density/optimum moisture content relationship        | BS 1377 : Part 4, Section 3 : 1990    |
| Hydraulic conductivity   | BS 1377 : Part 6, Section 6 : 1990    |
| Organic matter content   | BS 1377 : Part 3, Section 3 : 1990    |

TABLE 6.2: TYPICAL SUITABLE RANGES FOR PARAMETERS OF CLAY

| Property  | Range      | Comment  |
|---|------------|--|
| Percentage fines (particles less than 0.075mm)    | ≥ 20%      | A high clay content or a high silt and clay content will have a low hydraulic conductivity.  |
| Percentage gravel (particles greater than 4.76mm) | ≤ 30 %     |  |
| Plasticity Index                                  | 10 - 30 %  | Soils with low plasticity index are unlikely to achieve a sufficiently low permeability. Highly plastic soils tend to shrink and crack on drying while they are very sticky when the soil is wet and are therefore hard to work with in the field. |
| Maximum particle size                             | 25 - 50 mm | The particle size distribution curve should consist of well graded materials as these will tend to compact to a lower hydraulic conductivity. The particle size must not affect liner integrity.   |

The degree of compaction required for placement and the placement moisture content should be determined in association with permeability tests. The design should specify a range of moisture contents and corresponding soil densities (percent compaction) that are considered appropriate to achieve the required hydraulic conductivity.

The lower moisture content should be dictated by the permeability requirement. The upper limit to the moisture content may be dictated by the shear strength of the clay; because although the permeability requirement may be met, handling, compaction and trafficking become more difficult. This, in conjunction with stability considerations, dictates the requirements for a minimum shear strength. Typically an undrained shear strength ( $C_u$ ) of no less than than 40kN/m<sup>2</sup> is required.

The *in situ* density may be determined by nuclear density meter, core cutter or sand replacement method in accordance with BS 1377 : Part 9 : 1990. It should be noted that the nuclear density meter requires a permit from the Radiological Protection Institute of Ireland. To ensure the material is within the specified moisture content prior to placement the Moisture Condition Value (MCV) test (BS 1377 : Part 4 : 1990) may be used.

### 6.3.6 QUALITY ASSURANCE TESTING

Quality assurance and quality control needs to be carried out to:

- verify that construction materials are adequate;
- verify that the compaction process is adequate; and
- to ensure that the surface of the clay layer is smooth enough to prevent mechanical damage to the flexible membrane liner.

A quality assurance plan should provide details of tests, test frequencies, etc..

The following sections provide recommended minimum frequency testing for borrow sources and for soil lifts when the material is placed loosely and when compacted. Also provided is recommended maximum allowable variations for the loosely placed soil and the compacted soil. In addition to minimum frequency testing continuous observation of the construction process is required by the quality engineer, who may also prescribe or require further testing. Test samples may be taken at random or from a regular grid system.

**Borrow Source**

Testing of the borrow source needs to be performed to ensure the material is suitable for use and to identify processing requirements necessary to meet design specifications. Table 6.3 gives recommended minimum testing frequencies for a number of parameters.

**Loose Lift of Soil**

Recommended materials tests for soil liner materials sampled after placement in a loose lift (just before compaction) are given in Table 6.4.

**Non-conformities of Materials in Loose Lifts**

Soils by their nature are variable materials and it is inevitable that there will be deviations from the design specification. Recommended maximum allowable variations are given in Table 6.5 for materials sampled after placement in loose lifts. Materials which do not conform within the allowable variations must be repaired. The extent of failed area must be defined and repaired.

**Compacted Lifts of Soil**

Recommended minimum tests on compacted soil are given in Tables 6.6.

**Non-conformities of Compacted Soil Lifts**

Recommended maximum allowable variations are given in Table 6.7 for materials sampled after placement and compaction in lifts. Materials that do not conform within the allowable variations must be replaced. The extent of any failed area must be defined and repaired.

**Repair of sample/test holes**

Sampling locations in the liner system must be backfilled and sealed by bentonite or similar sealing material.

**6.4 BENTONITE ENHANCED SOILS (BES)**

Bentonite may be added to natural soils to improve permeability characteristics. Material suitability and specification should be assessed through manufacturers literature and by trial tests, including laboratory tests with a leachate of similar make up. BES may be used as a replacement for natural clay as outlined in the recommendations for liners in Section 6.2. The enhanced soil layer must be at minimum 0.5m and must give equivalent protection to that specified in Sections 6.2.1 to 6.2.3.

Bentonite may be supplied in granular or pulverised form. The dominant adsorbed cation in bentonite is usually sodium or calcium. Sodium bentonite has much greater water swelling and absorbency, but

calcium bentonite may be more stable when exposed to certain chemicals.

Bentonite is mixed with soils either in thin layers or in a batching plant. Mixing of soil spread in thin loose layers with bentonite distributed over the soil may be achieved with a specialised rotavator. A number of problems may arise from in-place mixing. These may include:

- mixing equipment not extending to an adequate depth and may not fully mix the loose lift of soil with bentonite;
- mixing device may dig too deeply into the ground and mix the loose lift in with underling materials;
- mixing equipment may fail to pass over all areas of the loose lift and may inadequately mix certain portions of the loose lift; and
- difficulties with mixing bentonite and soil on slopes greater than 33% (1:3).

For these reasons batch mixing may provide a more reliable means of mixing the soil and bentonite. Bentonite batching plants may also be computer controlled. In cases where BES are used mixing in a batching plant is recommended.

Construction of the BES should take place in lifts that are a maximum depth of 250mm when compacted. Quality assurance testing should be similar to that for a clay liner. Parameters that are important for quality control/quality assurance are:

- type of bentonite;
- grade of bentonite;
- grain size distribution of the processed bentonite;
- amount of bentonite added to the soil;
- type of soil used to prepare the BES; and
- uniformity of mixing of the bentonite with the soil.



TABLE 6.3: RECOMMENDED MINIMUM TESTING FREQUENCIES FOR INVESTIGATION OF BORROW SOURCE

| Parameter                    | Frequency  |
|------------------------------|--|
| moisture content             | 1 test per 2000m <sup>3</sup> or each change in material type  |
| Atterberg limits             | 1 test per 5000m <sup>3</sup> or each change in material type  |
| particle size distribution   | 1 test per 5000m <sup>3</sup> or each change in material type  |
| compaction tests             | 1 test per 5000m <sup>3</sup> or each change in material type  |
| hydraulic conductivity tests | 1 test per 10000m <sup>3</sup> or each change in material type |

TABLE 6.4: RECOMMENDED MATERIALS TESTS FOR SOIL LINER MATERIALS SAMPLED AFTER PLACEMENT IN A LOOSE LIFT (JUST BEFORE COMPACTION)

| Parameter                  | Testing Frequency |
|----------------------------|-------------------|
| moisture content           | 12/hectare/lift   |
| Atterberg limits           | 12/hectare/lift   |
| particle size distribution | 12/hectare/lift   |

TABLE 6.5: RECOMMENDED MAXIMUM ALLOWABLE VARIATION FOR MATERIALS SAMPLED AFTER PLACEMENT IN A LOOSE LIFT (JUST BEFORE COMPACTION)

| Parameter   | Maximum allowable variation  |
|---|--|
| Atterberg limits                                    | 5% (outliers not concentrated in one area or one lift) <sup>1</sup>  |
| percent fines                                       | 5% (outliers not concentrated in one area or one lift) <sup>1</sup>  |
| percent gravel                                      | 10% (outliers not concentrated in one area or one lift) <sup>1</sup> |
| clod size   | 10% (outliers not concentrated in one area or one lift) <sup>1</sup> |
| hydraulic conductivity of laboratory compacted soil | 5% (outliers not concentrated in one area or one lift) <sup>1</sup>  |

## Notes:

1. Samples that do not conform to the design specification but are within maximum allowable variation must not be concentrated in one area or one lift.

TABLE 6.6: RECOMMENDED MINIMUM TESTING FREQUENCIES ON COMPACTED SOIL

| Parameter                      | Test method                             | Testing frequency |
|--------------------------------|---|-------------------|
| moisture content               | nuclear method or microwave oven drying | 12/hectare/lift   |
| moisture content               | direct oven drying                      | 3/hectare/lift    |
| density                        | nuclear method or core cutter           | 12/hectare/lift   |
| density                        | sand replacement method                 | 3/hectare/lift    |
| hydraulic conductivity testing | triaxial test                           | 3/hectare/lift    |
| number of passes               | observation                             | 10/hectare/lift   |

## Notes:

1. In addition, at least one test for each parameter above should be performed each day soil is compacted and additional tests should be performed in areas for which QA personnel have reason to suspect inadequate compaction.
2. Every fifth sample tested for moisture using nuclear or microwave drying oven methods should be tested by direct oven drying to aid in identifying any significant systematic calibration errors.
3. Every fifth sample tested for density using nuclear or core cutter methods should also be tested (as close as possible to the same test location) using the sand replacement method to aid in identifying any systematic calibration errors.



TABLE 6.7: RECOMMENDED MAXIMUM ALLOWABLE VARIATIONS

| Parameter                      | Maximum allowable variation  |
|--------------------------------|--|
| moisture content               | 3% (outliers not concentrated in one area or one lift) <sup>1</sup> and no moisture content less than 2% or more than 3% of the allowable value      |
| dry density                    | 3% and no dry density less than 0.8kN/m <sup>3</sup> below the required value  |
| hydraulic conductivity testing | 5% (failing samples to have a hydraulic conductivity no greater than one-half to one order of magnitude above the target maximum value) <sup>2</sup> |
| number of passes               | 5% (outliers not concentrated in one area or one lift) <sup>1</sup>  |

Notes:

1. Samples that do not conform to design specification but are within maximum allowable variation must not be concentrated in one area or one lift.
2. If the hydraulic conductivity at a particular point is more than one-half to one order of magnitude too high, the zone should be retested or repaired regardless of how isolated it is.

### Bentonite testing

Testing of bentonite is similar to that for clay. Additional tests that may be carried out are highlighted below. In addition the frequency of testing is given in the table below. It should again be noted that this is in addition to the tests outlined for a clay liner.

### Quality of bentonite

This may be indicated by Atterberg limits. The higher the liquid limit and plasticity index the higher the quality of bentonite (Atterberg limit testing in accordance with BS 1377). The liquid limit for calcium bentonites is frequently in the range of 100 to 150%. A medium quality sodium bentonite will have a liquid limit of approximately 300 to 500%. High quality sodium bentonite typically has a liquid limit in the range of about 500 to 700%.

### Free swell test

This determines the amount of swelling of the bentonite when exposed to water (no standard - must refer to manufacturers literature). Calcium bentonites usually have a free swell of less than 6cc. Low grade sodium bentonites typically have a free swell of 8-15cc. High grade bentonites may have free swell values in the range of 18 to 28cc.

### Gradation of bentonite

Sieving of the bentonite as per BS 1377.

### Bentonite content

The recommended test for measuring the amount of bentonite in soil is the methylene blue test (Alther, 1983). It is based on titrating methylene blue into a material and the amount of methylene blue required to saturate the material is determined. The more bentonite in the soil the greater the amount of methylene blue that must be added to achieve saturation. Typically the bentonite content of a BES may be in the range 5 to 15%. This test works well for non-clayey soils.

TABLE 6.8: RECOMMENDED BENTONITE CONTENT TEST FOR BES LINER MATERIALS SAMPLED AFTER PLACEMENT IN A LOOSE LIFT (JUST BEFORE COMPACTION)

| Parameter         | Test Method   | Minimum testing frequency |
|-------------------|---------------|---------------------------|
| percent bentonite | Alther (1983) | 1 per 800m <sup>3</sup>   |

Note : the recommended maximum percentage of failing material tests for the above test is 5% and outliers must not be concentrated in one lift or one area.

The moisture content of the bentonite paste reduces as the dry density increases (less voids to fill). The use of well graded soils or soils with a high percentage fines content which can achieve high dry densities can reduce the bentonite demand, improve the permeability of the mix and its chemical resistance. The paste must be at an acceptable moisture content if a low permeability is to be achieved and also resistance to chemical effects, drying and freezing.

## 6.5 GEOSYNTHETIC CLAY LINERS

Geosynthetic clay liners (GCL) typically consist of a composite matting comprising a bentonite layer approximately 6mm thick between 2 layers of geotextile by stitching, needle punching or glueing and are factory manufactured. They are used to augment or replace compacted clay or geomembranes in either the basal liner or the final capping system. A liner system incorporating a GCL must give equivalent protection to that specified in Sections 6.2.1 to 6.2.3. The use of GCL's in liner systems is not recommended until its equivalence to the foregoing systems has been demonstrated.

Details that must be taken into account when using a GCL are similar to those of the geomembrane (Section 6.6). Consideration must be given to the following details which should be fully covered in the specification and the quality assurance plan:

- **Manufacture:** this includes the selection of the raw materials, the manufacturing of these materials into a GCL and covering the rolls of GCL with a waterproof plastic cover;
- **Handling:** includes the storage of the material both at the factory and on site, as well as the transporting of the material to site. The quality assurance personnel should certify that the material has passed conformance testing and is acceptable for the installation stage; and
- **Installation:** includes placement of the material - the substrate layer, whether soil or a geosynthetic must be approved prior to placing of the GCL. Joining of the material - the overlapping distance should be specified. This is typically a minimum of 150 to 300mm, a connection of the overlap may not be needed depending on the material type. The placement procedure should be clearly identified, including defects repairing and covering / backfilling of the GCL after the quality assurance personnel approved it.

## 6.6 GEOMEMBRANES (FLEXIBLE MEMBRANE LINERS)

There are many types of geomembranes, or flexible membrane liners as they are often called, available. A geomembrane for use as a component in a basal landfill liner should have a low permeability, a physical strength capable of withstanding mechanical stresses and strains, and be chemically compatible with the waste contained by the liner.

Mechanical stresses that the geomembrane may be subject to take the form of both short term and long term stresses. Short term stresses can originate from trafficking during installation while long term stresses can result from the placement of waste and from subsequent differential settlement in the foundation soils. The geomembrane must have sufficient strength to meet the strain requirements at anchor trenches and on side slopes.

### 6.6.1 GEOMEMBRANE SELECTION

Basal liner geomembranes need to have long term chemical stability, while membranes on an inclined slope will in addition require suitable friction characteristics. Manufacturers usually provide a list of chemicals with test results indicating the liner performance. If the chemical compatibility of liners with site specific leachates is required USEPA Method 9090, or appropriate ASTM Standards or equivalent may be used.

Design considerations which affect choice of geomembrane material include:

- the ability to support its own weight on the side slopes;
- withstanding downdragging during and after waste placement;
- the best anchorage configuration;
- stability of soil cover; and
- stability of other geosynthetic components.

### Geomembrane thickness

Typical thickness of geomembranes for use in basal liner systems ranges from 1.5 to 2.5mm. Use of a minimum 2.00mm thick geomembrane is recommended as it provides greater resistance to contaminant breakthrough thus increasing the containment system design life and the greater thickness increases the tensile strength, tear and puncture resistance.

### Geomembrane stability

Careful evaluation of interface friction is required between the various layers of soil and geosynthetic materials i.e. geomembranes, drainage media, to ensure stability during construction and at the various stages of waste filling. Shear box tests using site specific materials are essential.

### 6.6.2 GEOMEMBRANE STANDARDS

Current accepted standards for geomembrane testing are the United States 'ASTM' and the German 'DIN' standards. The NSF (National Sanitation Foundation) standard on flexible membrane liners, NSF Standard 54, has been discontinued since the end of 1997. The GRI (Geosynthetic Research Institute) has a standard for HDPE Geomembranes called the GM13. A BSI committee (B/546/8) is working on a series of publications regarding geosynthetics, as of yet there has been no publication from this group. Manufacturers normally supply a material specification that should be used by the designer to ensure the selected geomembrane satisfies stresses anticipated during the design life.

### 6.6.3 GEOMEMBRANE PROCESS - RAW MATERIAL TO LANDFILL SYSTEM AND INSTALLATION COMPONENT

The main considerations in the handling and installation of a geomembrane from raw material to landfill system component are highlighted and discussed in the following section. It is recommended that further details on specific applications be obtained from manufacturers literature. A quality assurance/quality control plan should contain details of these considerations which are as follows:

- manufacture;
- handling (packaging/storing/transporting);
- placement;
- seaming/jointing;
- destructive/non destructive testing; and
- protection and backfilling.

#### **Manufacture**

Geomembranes are relatively thin sheets of flexible thermoplastic or thermoset polymeric materials that are manufactured and prefabricated at a factory and transported to the site. Manufacturing of the geomembrane includes the selection of the specific type of geomembrane, its formulation and manufacture into a continuous sheet.

Geomembranes are composed of one or more polymer along with a variety of other ingredients such as carbon black. The principal process used for manufacture of geomembranes is extrusion followed by additional processing such as calendaring, film blowing, etc. The most commonly used geomembranes for solid or liquid waste containment are listed below:

- HDPE;
- LLDPE;
- Other extruded types;
- PVC;
- CSPE; and
- Other calendared types.

HDPE is the most common geomembrane used in

landfill basal liner systems. It has good chemical and biological resistance and a good ability to be seamed. Advantages and disadvantages of the basic polymers of geomembranes are given in Appendix C, Table C.1.

Compliance testing should be performed to ensure that the materials meet the specification.

#### **Handling**

Handling includes packaging, storing and transporting of the liner. The quality assurance personnel should certify that the geomembrane is in compliance with the minimum standards once it reaches site. The delivery location, storage arrangements, and mechanism of transport on site should be detailed in the specification.

#### **Installation**

The specification should either detail the installation procedures or request the installer/contractor to provide details that should include geomembrane layout plan, deployment of the geomembrane at the construction site, seam preparation, seaming methods, detailed procedures for repairing and documenting construction defects, and sealing of the geomembrane to appurtenances, both adjoining and penetrating the liner, quality control destructive and non destructive tests.

The layout plan should provide panel identification with location, roll number, sequence and direction of sheet installation. The method of laying the sheets should be specified, including the laying and cutting of the geomembrane around appurtenances and anchor trenches. Field installation should take account of access to site, wind direction, subgrade surface and site drainage. Installation should not proceed when adverse conditions prevail.

The quality of a geomembrane lining system depends on the quality of installation. Prior to placement the soil subgrade or other sub-base material should be checked for its readiness. During installation construction equipment should not be allowed to traffic directly on the geomembrane.

#### **Anchor Trench**

To prevent slippage and creasing the membrane needs to be bedded in an anchor trench. A normal minimum requirement is that the trench should be 1m back from the top edge of the slope, and should be 0.6m deep by 0.6m wide. Dimensions may be varied according to the tensile loads anticipated in the geomembrane and the strength of the soils comprising the crest of the embankment. In some cases it may be a design requirement to provide only

limited anchorage in order to allow slippage in the event of excessive tensile loads in the geomembrane. A typical anchor trench is illustrated in Figure 6.3.

### Seaming/Joining

Seaming of the membrane may be performed either in the factory or on the site. There are several methods for the construction of both factory and field seams. Table 6.9 gives some commonly used methods.

TABLE 6.9: GEOMEMBRANE BONDING METHODS

|                  |           |                        |
|------------------|-----------|------------------------|
| Thermal Process  | Extrusion | Fillet                 |
|                  |           | Flat                   |
| Chemical Process | Fusion    | Hot wedge              |
|                  |           | Hot air                |
|                  | Chemical  | Chemical fusion        |
|                  |           | Bodied chemical fusion |
|                  | Adhesive  | Chemical adhesive      |
|                  |           | Contact adhesive       |

The above methods include solvents, heat seals, heat guns, dielectric seaming, extrusion welding, and hot wedge techniques. The selection of a bonding system for a particular geomembrane is dependent primarily on the polymer making up the sheeting and the geomembrane should be sealed using the bonding system recommended by the manufacturer.

Thermal and adhesive methods have the same requirements in so far as they require a clean bonding surface, pressure and time to produce high quality seams with the principal difference being that of the requirement of heat for the thermal process instead of an adhesive.

### Field welding

The most critical component of any installation of the geomembrane is the field welding of seams. In order for the geomembrane to perform satisfactorily the seaming must be performed adequately. On hot days where the air temperature is expected to vary appreciably through the day then welding should be confined to early morning or late afternoon. This will prevent excessive wrinkling or spanning (strain induced as sheet contracts). Prior to seaming the seam should be free of moisture, dust, dirt or debris of any nature. Seams horizontally across slopes and at the toe of slopes should be avoided because these seams may be subjected to excessive stresses. Typically the minimum distance from the toe of the slope for geomembrane seaming is 1.5m.

In the field, fusion wedge welding is the primary method for joining two adjacent overlapped

geomembranes. The wedge welder creates a fusion weld by heating the facing overlapped surfaces and then pressing them together while in a molten state. Wedge welds produce a single or double track weld. The air channel between the weld track(s) is used to non destructively air pressure test the integrity of the seam.

Extrusion welding is carried out where fusion wedge welding is impractical. For this type of welding the overlapped sheets are first tack welded and then the liner surface area to be welded is abraded. At the sheet overlap, the extrusion welder integrates molten polyethylene into the prepared geomembrane seam to create a permanent weld. Figure 6.4 shows the fusion wedge weld and the extrusion weld.

### Trial seam welds

Trial seams should be performed on test strips to verify that seaming conditions are adequate. Trial seams should be conducted under the same conditions as will be encountered during actual seaming. Test strips should be used to estimate the quality of the production seams while minimising damage to the installed geomembrane through destructive mechanical testing. Test strips should be made at the beginning and end of every work shift. They should also be made whenever personnel or equipment are changed and when climatic conditions reflect wide changes in geomembrane temperature or when other conditions occur that could affect seam quality.

### Destructive testing

Destructive and non destructive testing assures that the seams are fabricated to the highest quality and uniformity and are in compliance with the project specifications. Destructive testing of seams give direct evaluation of seam strength and bonding efficiency which indicate seam durability. Field and laboratory destructive testing involves two techniques; shear testing and peel testing. Shear testing applies a tensile stress from the top sheet through the weld and into the bottom sheet. Peel testing peels the top sheet back against the overlapped edge of the bottom sheet in order to observe how separation occurs, this test indicates whether or not the sheets are continuously and homogeneously connected though the seam. The sample in each test should exhibit a film tear bond, that is the sheet yields or tears before the weld pulls apart.

Destructive testing on the installed liner should be kept to a minimum through the use of trial seam tests as direct sampling will require subsequent patching. Where destructive testing is considered necessary a

sample of appropriate size should be cut and identified to the geomembrane roll/panel. Ten specimens should be cut from this sample, five for shear testing and five for peel testing. The tested seams should exhibit a film tear bond. When four of the five specimens meet this test criteria it constitutes a passing test.

In addition to the above the specimens must meet or exceed strength requirements. For seams tested in shear mode, failure forces of 80 to 100% of the unseamed sheet strength are usually specified (95% for HDPE) for acceptability compared to 50 to 80% (62% for HDPE) for those tested in the peel mode. For specification purposes weld strength should be expressed as a percentage of the minimum specified tensile strength.

Where seams fail the above tests further testing of the seam on each side of the cut sample is required until a passing result is obtained. If a large number of samples fail it may be necessary to replace the entire seam. Where defects are identified in the liner they should be repaired and non destructively tested.

#### **Non destructive testing**

Non destructive testing is performed to check continuity of seams. Field seams should be non destructively tested for their full length. This testing should be carried out as the seaming work progresses. Non destructive test methods include using vacuum test unit (extrusion weld seams), air pressure testing (fusion wedge welding seams), or other approved method (for example spark testing and ultrasonic testing).

In the air pressure test, pressure must be maintained in the air channel for five minutes to verify the seam is free of leaks. The pressure to be applied is normally between 200kPa and 240kPa for geomembranes of 2 and 2.5mm thickness. The pressure loss after five minutes should not exceed 15kPa. At the end of the test, the air pressure is released at the opposite end of the seam to that of application to ensure that the air channel is continuous and that the entire length of the weld has been tested. In the box test a soap solution is applied to the seam and the vacuum box is placed over the seam area. A vacuum of minimum 35kPa is pulled in the box. The geomembrane is examined for 10 to 15 seconds. Leaks are indicated by bubbling of the soap solution where air is pulled through the seam.

Where a non destructive test fails the leak area should be identified and repaired. This area should be then tested again, usually by using the vacuum test.

#### **Protection and backfilling**

Geomembranes should be covered as soon as possible after quality assurance activities associated with the geomembranes testing are completed and the geomembrane has been certified by the CQA personnel. It must be covered with either a soil or with a layer of geosynthetics depending on the positioning of the geomembrane.

Most manufacturers offer guidelines in relation to the final preparation of the subgrade and to the materials placed over the geomembrane. The compatibility of covering underlying soils with the proposed geomembrane, whether with or without geotextile protection, should be demonstrated by means of a cylinder test or similar laboratory procedure providing a quantitative result. Such testing should be additional to any site trial.

Laboratory performance tests have been developed to test the performance efficiency of geotextiles. The cylinder test is an example of such a test. This test is used to assess the performance of geomembrane protection systems by subjecting a section of the lining system to a constant loading. The effectiveness of the geotextile in protecting the geomembrane from stresses can be determined. The test is generally based on the principle of applying design loads onto a geotextile/geomembrane combination and assessing either the stress at rupture or using telltale plates to assess the degree of strain.

If the cover material is to be a soil, it may be necessary to specify the maximum particle size. This should be based on manufacturers guidelines or trial tests. Soil cover with a maximum particle size of 25mm might be acceptable if all particles are rounded in shape and there is a broad distribution e.g. 40% less than 5mm. However, if crushed, angular material is used then a maximum particle size of 6mm should be specified. There is a complex relationship between puncturing of the geomembrane and the maximum particle size, particle size distribution, particle shape, thickness of the geomembrane and construction and operational loads, including the mode of deployment of the covering material. In some instances the cover material may also be designed to function as the drainage layer.

Geosynthetic materials covering the geomembrane may include a geotextile, a geonet, a geogrid (for reinforcement on slopes) or a drainage geocomposite. If geosynthetic material is placed above the geomembrane then sufficient temporary ballasting must also be provided to secure the system against wind damage.



## 6.7 GEOMEMBRANE LEAK LOCATION SURVEYS (GLLS)

Electrical leak location surveys should be undertaken on newly constructed landfill liners to investigate the presence of holes through the geomembrane. Detected holes should be repaired before the landfill is brought into service.

The number of leaks found in geomembrane liners is related to the quality of installation and to the specification and control of the material above and below the geomembrane. A good CQA will reduce the number of defects. Electrical leak detection surveys should be used to compliment the CQA programme. The GLLS should demonstrate that the lining system, as built, achieves leakage rates less than those specified. To know the likely leakage rates it is vital to know the state of the geomembrane post placement of the protective/drainage layer and prior to commencement of landfilling. Examples of leakage rate calculations are presented in Appendix C.

Leak location surveys take two forms:

- mobile leak location surveys; and
- permanent leak location surveys.

Both surveys operate on the principle of exploiting the insulating properties of the FML. The systems work by passing an alternating current into the ground and measuring the resistivity of the underlying or surrounding strata. The integrity of the flexible membrane liner can be tested by passing current from an electrode placed above the FML liner to an electrode grid placed below. The FML is an electrical insulator, hence when there are no defects within the liner, an electrical current has no way of flowing through it. However, if a hole is present, current flow is possible and an increase in electrical potential will be observed in the vicinity of the defect. A strip of the flexible membrane liner must be left exposed around the perimeter of the area to be tested so that the leachate collection layer and FML protection layer are electrically isolated from the ground outside the lined area. Defects should be repaired and retested.

These techniques may be used to test the integrity of lined lagoons or impoundments for the storage/treatment of leachate or other liquid.

### Mobile Leak Location Surveys

Mobile leak location surveys are capable of detecting holes in the FML beneath soil cover

(protection/leachate collection layers). The sensitivity of the electrical signal usually decreases as the thickness of soil cover increases. Defects of 6mm<sup>2</sup> can be detected when the FML is covered with 0.6m of soil. The technique is dependent on electrical current transmitted through soils via the soil moisture. Mobile leak location surveys should be undertaken at all sites installing FML during or post placement of the protection, leachate collection layers (the exact time the survey should be carried out will depend on the thickness of the protection layer and leachate collection layer).

The electrical measurements are typically made on a 0.5m by 1m grid pattern. When a suspect area is indicated in the processed data (done on-site so leaks can be immediately marked for repair), further measurements are taken to precisely localise the leak. The defect should then be uncovered, repaired and retested.

### Permanent Leak Location Surveys

The permanent leak location survey consists of a grid of electrodes installed beneath the composite liner (below the FML and the soil component). Typical grid spacing may vary from 10 to 20m. The equipment must be simple and durable, as once buried it is usually irretrievable for routine maintenance or repair. When a defect is identified within the grid spacing it is subsequently pinpointed using a portable volt meter and moving probe. The defect should then be uncovered, repaired and retested.

## 6.8 FIELD TRIALS

Geotechnical properties of the materials and construction procedures to be used in the placing of the landfill liner should be tested prior to construction. A trial constructed under controlled conditions should be used to verify the performance objectives. Field trials should be planned, specified, supervised and interpreted by a chartered geotechnical engineer.

The field trial must be designed to provide the following information:

- suitability of the materials under site conditions;
- ability of the materials to achieve the geotechnical design criteria;
- suitability of the method of placement and compaction methods to achieve the design criteria; and

- information for the construction method statement for the liner. This should include types of tests, testing frequencies, equipment used, lift thickness, and number of passes of the compacting equipment.

*In situ* hydraulic conductivity tests may be performed on the trial pad. Undisturbed soil samples may be used to simulate field conditions in the laboratory.

**FIGURE 6.3: TYPICAL ANCHOR TRENCH DETAIL**

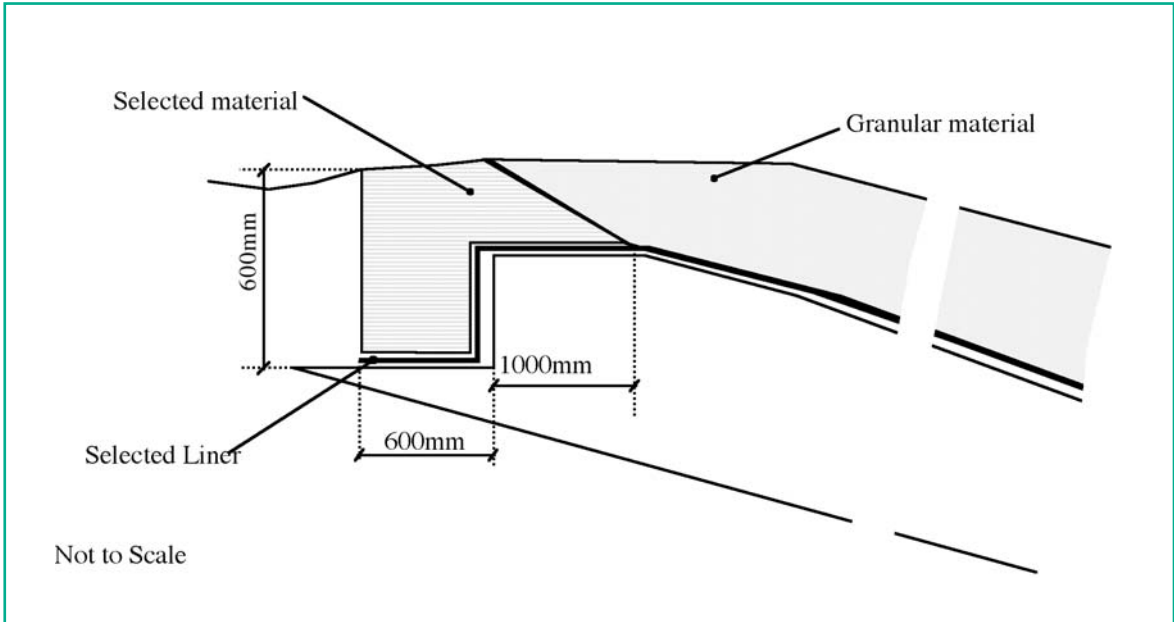

**FIGURE 6.4: TYPICAL WELD DETAILS**

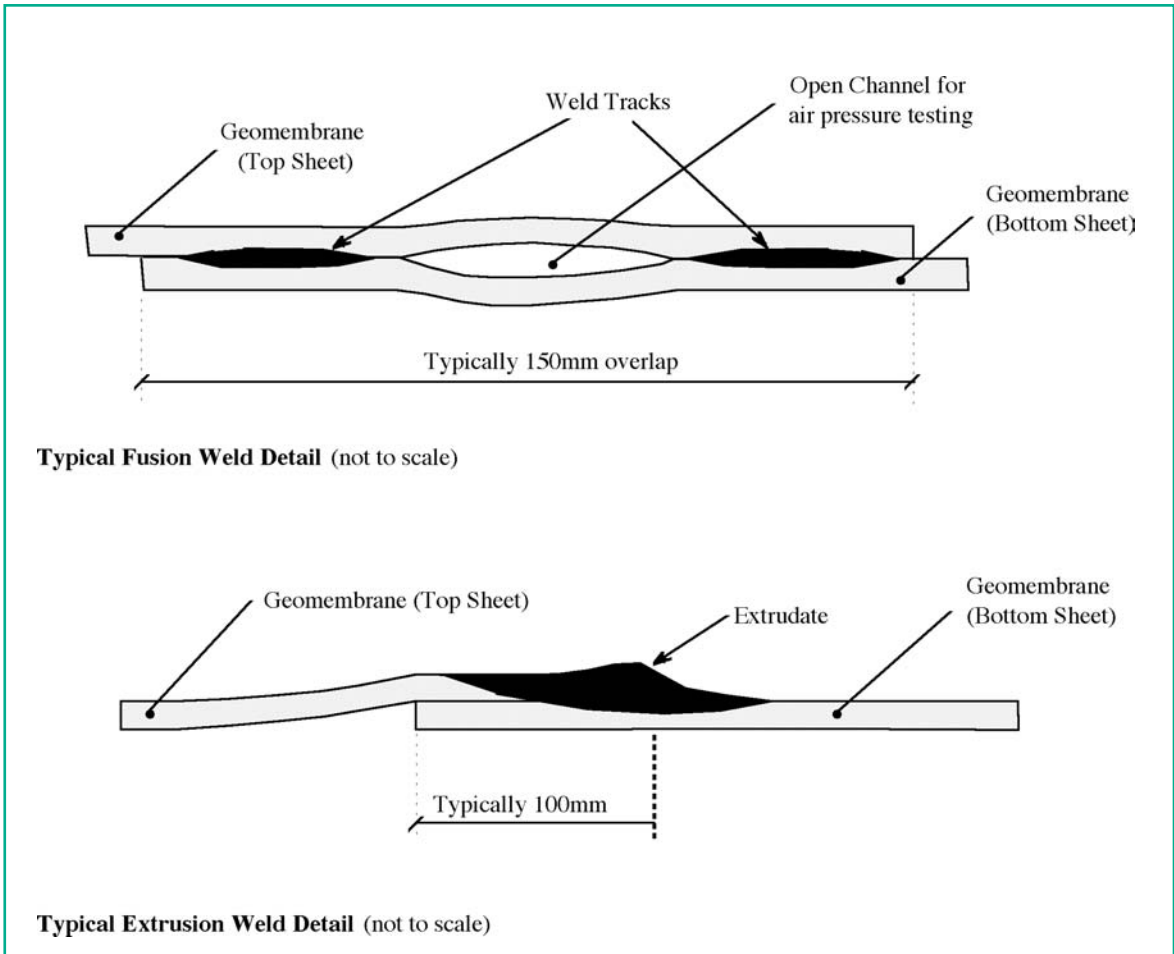



## 7. LEACHATE MANAGEMENT

### 7.1 LEACHATE MANAGEMENT

#### 7.1.1 INTRODUCTION

Leachate produced in a landfill is a liquid which has percolated through the waste, picking up suspended and soluble materials that originate from or are products of the degradation of the waste.

Before considering the design of any leachate management system it is important to consider the objectives that are to be achieved. Leachate needs to be controlled in a landfill for the following reasons:

- to reduce the potential for seepage out of the landfill through the sides or the base either by exploiting weaknesses in the liner or by flow through its matrix;
- to prevent liquid levels rising to such an extent that they can spill over and cause uncontrolled pollution to ditches, drains, watercourses etc.;
- to influence the processes leading to the formation of landfill gas, chemical and biological stabilisation of the landfill;
- to minimise the interaction between the leachate and the liner; and
- in the case of above ground landfill, to ensure the stability of the waste.

A leachate management plan should be developed. Part of this plan should include explicit information on the manner in which the leachate is managed and measures in place to minimise its generation. Details on leachate recirculation rate (if proposed) and a discussion of how continued monitoring of the liner's performance will relate to leachate recirculation and the hydraulic loading of the landfills Leachate Collection and Removal System (LCRS) should be included. The plan should also address such items as the potential for leachate surface seeps, odour issues, remedial cleaning/flushing of the LCRS to ensure free-flow conditions and the potential for increased leachate leakage through the liner.

#### 7.1.2 MAIN CONSTITUENTS

The principal organic content of leachate is formed during the breakdown processes summarised in Figure 7.1. It is normally measured in terms of Biochemical Oxygen Demand (BOD), Chemical Oxygen Demand (COD) or Total Organic Carbon (TOC). The quality of municipal landfill leachate changes with time as the degradation of the waste continues inside the landfill. The degradation process is generally divided into five successive stages, namely (i) aerobic, (ii) hydrolysis and fermentation, (iii) acetogenesis (iv) methanogenic and (v) aerobic phase (Figure 7.2). These processes are dynamic, each stage being dependent on the creation of a suitable environment by the preceding stage.

Stage III leachate is characterised by a high organic material content with a BOD/COD ratio of greater than 0.4, and a low pH. After the transition to the methanogenic phase (stage IV), the organic materials concentration and the BOD/COD ratio of the leachate decrease rapidly while the pH value increases. A BOD/COD ratio of less than 0.25 is typical of the methanogenic phase leachate. The concentration of certain compounds like nitrogen, ammonium, phosphorus and chloride do not change significantly between these phases. Ammonia is probably the most important inorganic contaminant with the greatest potential to adversely impact on surface water and groundwaters. However, other components such as heavy metals and sulphides may be significant in certain circumstances. Iron and calcium are particularly important with respect to the precipitation of solids whilst elevated salinity levels are ubiquitous. It should be noted that the site specific discharge requirements will determine the components that require treatment or removal.

Organic compounds that are hazardous at low concentrations may also be present, e.g. pesticides (atrazine, simazine), AOX (adsorbable organic halogens) compounds, etc. Most are man made but some may be formed within the landfill.

FIGURE 7.1: MAJOR STAGES OF WASTE DEGRADATION

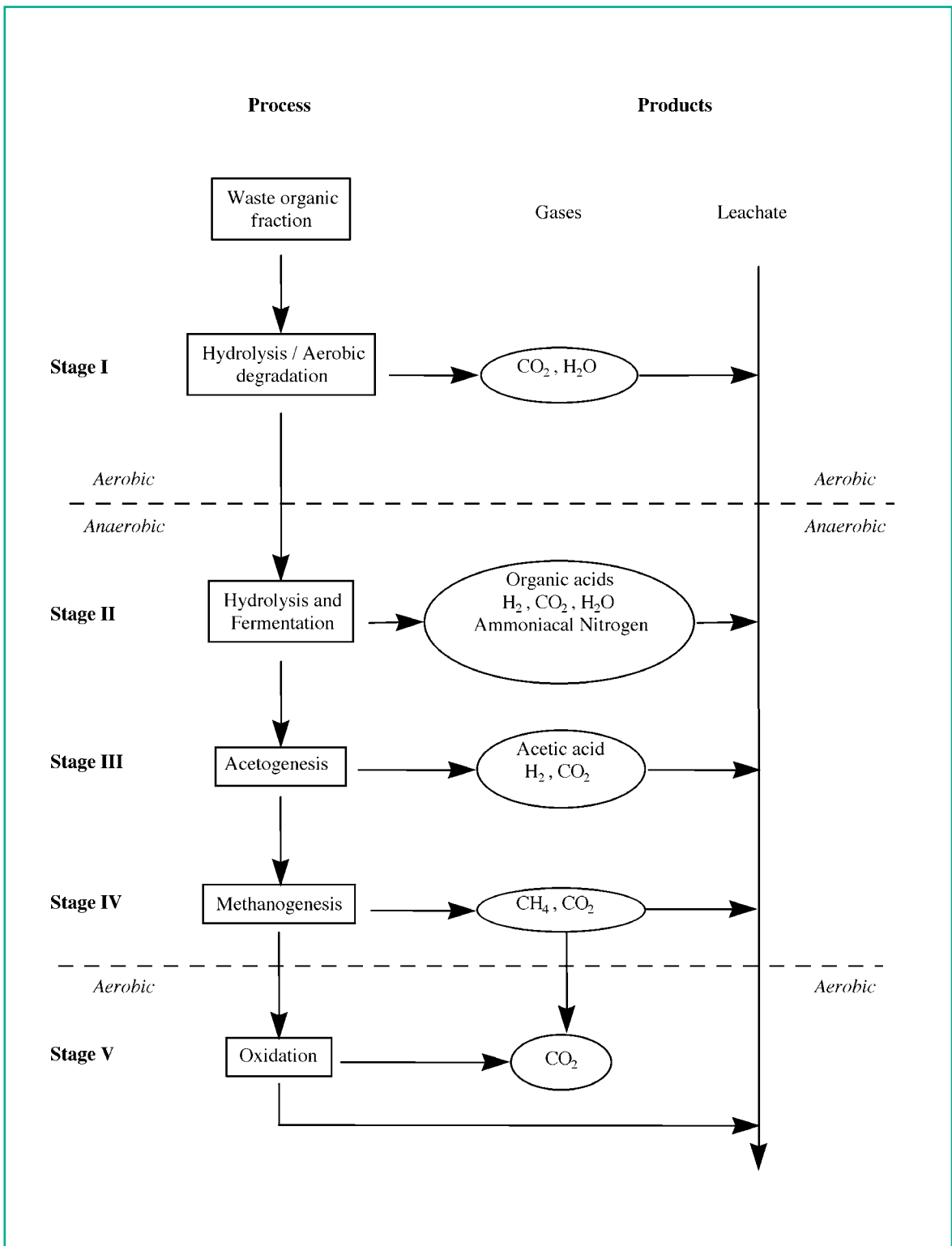
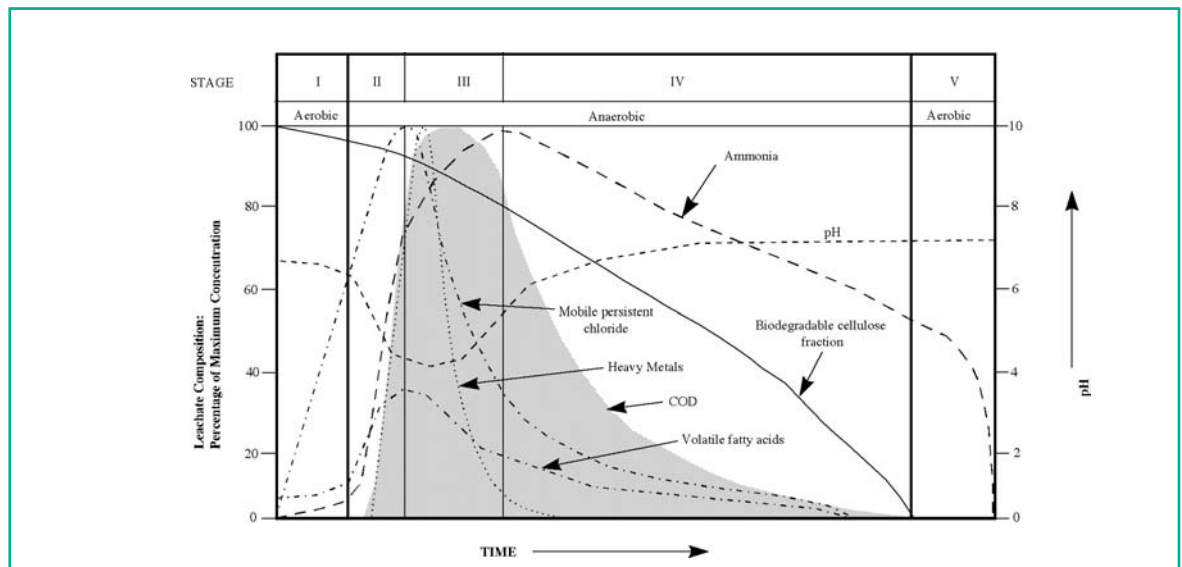

FIGURE 7.2: CHANGES IN LEACHATE COMPOSITION (SOURCE UK DOE 1991)



Leachate generally contains larger pollutant loads than urban waste water. However, unlike waste water, leachate usually has high nitrogen and low phosphorus concentrations.

Details of the constituents of acetogenic, methanogenic and hazardous/inert leachates are outlined in Tables 7.1, 7.2 and Appendix D.1, respectively.

### 7.1.3 SIGNIFICANCE OF CONSTITUENTS OF LEACHATE

The composition of the leachate is an indication of the state of the biological processes occurring within the waste body and the solubility of the ions. If leachate is to be removed and treated certain parameters will have particular environmental and economic significance. This significance will alter with the route for treatment/disposal chosen. The most significant parameters are discussed below:

#### Ammonia

Over extended timescales ammoniacal-N is the contaminant with the greatest potential to adversely impact upon surface waters and groundwaters in the vicinity of landfills. It will be several decades before concentrations of ammoniacal nitrogen will fall to values where direct release to a watercourse becomes a viable option.

Ammonia exhibits toxicity to fish and may not be discharged to surface water bodies other than in very low concentrations. For both fresh water and salt water the majority of research studies show acute

toxicity effects for salmonid and non-salmonid fish species between 0.002 and 10mg/l un-ionised ammonia. Ammonia is treated in aerobic processes accompanied by a concomitant increase in nitrate concentrations. It should be noted that nitrate levels in surface waters should not exceed 50mg/l.

#### Organic loading

This term refers to the organic compounds present in the leachate. The main significance of organic loading is its effect on watercourses where the compounds are broken down aerobically causing dissolved oxygen levels in the watercourses to fall and so threaten fish. The organic loading can be measured by a number of analytical methods, e.g. Total Organic Carbon (TOC), Chemical Oxygen Demand (COD) and Biological Oxygen Demand (BOD). The amount of organic carbon present in leachate will affect the method of treatment and the suitability of the leachate or effluent for discharge to a watercourse. In general, discharge consents are in COD terms (charging formula based on COD) whereas surface water discharges are normally consented in terms of BOD (impact on flora and fauna).

#### Chloride

Leachate contains the final soluble degradation products of waste which are in the main simple ions. The major contributor to this ionic strength is chloride and this can cause a problem to fish life and can be prejudicial to other water users. For sewer discharges restrictions are less likely due to dilution by other effluents.

### Phosphorous

The levels of total phosphorous in leachates is low (see Tables 7.1, 7.2 for values recorded at UK landfill sites). In fact, the treatment of leachates at wastewater treatment plants may require the addition of phosphorous as a nutrient for bacterial growth. The Urban Waste Water Treatment Regulations (SI No. 419 of 1994) sets requirements (which includes concentration of total phosphorous) for discharges from urban waste water treatment plants to listed sensitive areas which are subject to eutrophication. The Local Government (Water Pollution) Act, 1977 (Water Quality Standards for Phosphorous) Regulations, 1998 (SI No. 258 of 1998) provide for specified improvements in water quality conditions in rivers and lakes. Regard must be taken of these Regulations when discharges from leachate treatment plants are being examined. This should consider assimilative capacity and the dilution available in the receiving water.

### Metals

Conditions within the landfill during the acetogenic phase are such that the leachate can be chemically aggressive so that the resulting leachate may contain high concentrations of iron, manganese, calcium and magnesium. During the methanogenic stage the heavy metals are rendered insoluble and levels of dissolved metals tend to be low. Where high concentrations do occur they will need to be reduced during treatment as both sewer and surface water discharge consents will contain limits on these substances. In general however, metals are in concentrations below those routinely determined in domestic sewage (UK DOE 1995).

### Sulphate

Sulphate levels may be restricted in discharge consents. Methanogenic leachate generally contains low concentrations (median of 35mg/l) whereas on average acetogenic leachate contains up to 10 fold higher sulphate concentration. Sulphates if present are likely to cause a problem due to reduction to hydrogen sulphide which gives rise to odour problems at low odour thresholds.

### Dissolved gases

For discharge to sewer prior physical treatment to remove methane, carbon dioxide, and hydrogen sulphide may be necessary to prevent build up of explosive, asphyxiating or toxic gases in the sewer. Discharges to surface water will require aeration and as such should only contain atmospheric gases.

### Other compounds

It is important that the List I and List II substances referred to in the EU Directives on Dangerous Substances (76/464/EEC) and Groundwater (80/68/EC) and amendments are prevented from being discharged or limited so that surface water or groundwater pollution is prevented.

Certain substances, both organic and inorganic are highly restricted by virtue of their toxicity and persistence in the aquatic environment. For example, concentrations of lead and AOX are limited to 0.5mg/l in German standards. Some of these materials are present in leachates in trace quantities and may significantly restrict any discharge to surface water and/or sewer networks.

**TABLE 7.1: SUMMARY OF COMPOSITION OF ACETOGENIC LEACHATES SAMPLED FROM LARGE LANDFILLS WITH A RELATIVELY DRY HIGH WASTE INPUT RATE**

| Determinant                       | Overall Range |         | Overall Values |        |
|-----------------------------------|---------------|---------|----------------|--------|
|                                   | Minimum       | Maximum | Median         | Mean   |
| pH-value                          | 5.12          | 7.8     | 6.0            | 6.73   |
| conductivity ( $\mu\text{S/cm}$ ) | 5,800         | 52,000  | 13,195         | 16,921 |
| alkalinity (as $\text{CaCO}_3$ )  | 2,720         | 15,870  | 5,155          | 7,251  |
| COD                               | 2,740         | 152,000 | 23,600         | 36,817 |
| BOD <sub>20</sub>                 | 2,000         | 125,000 | 14,900         | 25,108 |
| BOD <sub>5</sub>                  | 2,000         | 68,000  | 14,600         | 18,632 |
| TOC                               | 1,010         | 29,000  | 7,800          | 12,217 |
| fatty acids (as C)                | 963           | 22,414  | 5,144          | 8,197  |
| ammmoniacal-N                     | 194           | 3,610   | 582            | 922    |
| nitrate-N                         | <0.2          | 18.0    | 0.7            | 1.8    |
| nitrite-N                         | 0.01          | 1.4     | 0.1            | 0.2    |
| sulphate (as $\text{SO}_4$ )      | <5            | 1,560   | 608            | 676    |
| phosphate (as P)                  | 0.6           | 22.6    | 3.3            | 5.0    |
| chloride                          | 659           | 4,670   | 1,490          | 1,805  |
| sodium                            | 474           | 2,400   | 1,270          | 1,371  |
| magnesium                         | 25            | 820     | 400            | 384    |
| potassium                         | 350           | 3,100   | 900            | 1,143  |
| calcium                           | 270           | 6,240   | 1,600          | 2,241  |
| chromium                          | 0.03          | 0.3     | 0.12           | 0.13   |
| manganese                         | 1.40          | 164.0   | 22.95          | 32.94  |
| iron                              | 48.3          | 2,300   | 475            | 653.8  |
| nickel                            | <0.03         | 1.87    | 0.23           | 0.42   |
| copper                            | 0.02          | 1.1     | 0.075          | 0.13   |
| zinc                              | 0.09          | 140.0   | 6.85           | 17.37  |
| arsenic                           | <0.001        | 0.148   | 0.010          | 0.024  |
| cadmium                           | <0.01         | 0.1     | 0.01           | 0.02   |
| mercury                           | <0.0001       | 0.0015  | 0.0003         | 0.0004 |
| lead                              | <0.04         | 0.65    | 0.3            | 0.28   |

Notes:  
Results in mg/l except pH-value and conductivity ( $\mu\text{S/cm}$ ).  
Source: UK Department of the Environment (1995)

**TABLE 7.2: SUMMARY OF COMPOSITION OF METHANOGENIC LEACHATES SAMPLED FROM LARGE LANDFILLS WITH A RELATIVELY DRY HIGH WASTE INPUT RATE**

| Determinant                              | Overall Range |         | Overall Values |        |
|--|---------------|---------|----------------|--------|
|  | Minimum       | Maximum | Median         | Mean   |
| pH-value                                 | 6.8           | 8.2     | 7.35           | 7.52   |
| conductivity ( $\mu\text{S}/\text{cm}$ ) | 5,990         | 19,300  | 10,000         | 11,502 |
| alkalinity (as $\text{CaCO}_3$ )         | 3,000         | 9,130   | 5,000          | 5,376  |
| COD                                      | 622           | 8,000   | 1,770          | 2,307  |
| BOD <sub>20</sub>                        | 110           | 1,900   | 391            | 544    |
| BOD5                                     | 97            | 1,770   | 253            | 374    |
| TOC                                      | 184           | 2,270   | 555            | 733    |
| fatty acids (as C)                       | <5            | 146     | 5              | 18     |
| ammmoniacal-N                            | 283           | 2,040   | 902            | 889    |
| nitrate-N                                | 0.2           | 2.1     | 0.7            | 0.86   |
| nitrite-N                                | <0.01         | 1.3     | 0.09           | 0.17   |
| sulphate (as $\text{SO}_4$ )             | <5            | 322     | 35             | 67     |
| phosphate (as P)                         | 0.3           | 18.4    | 2.7            | 4.3    |
| chloride                                 | 570           | 4,710   | 1,950          | 2,074  |
| sodium                                   | 474           | 3,650   | 1,400          | 1,480  |
| magnesium                                | 40            | 1,580   | 166            | 250    |
| potassium                                | 100           | 1,580   | 791            | 854    |
| calcium                                  | 23            | 501     | 117            | 151    |
| chromium                                 | <0.03         | 0.56    | 0.07           | 0.09   |
| manganese                                | 0.04          | 3.59    | 0.30           | 0.46   |
| iron                                     | 1.6           | 160     | 15.3           | 27.4   |
| nickel                                   | <0.03         | 0.6     | 0.14           | 0.17   |
| copper                                   | <0.02         | 0.62    | 0.07           | 0.13   |
| zinc                                     | 0.03          | 6.7     | 0.78           | 1.14   |
| arsenic                                  | <0.001        | 0.485   | 0.009          | 0.034  |
| cadmium                                  | <0.01         | 0.08    | <0.01          | 0.015  |
| mercury                                  | <0.0001       | 0.0008  | <0.0001        | 0.0002 |
| lead                                     | <0.04         | 1.9     | 0.13           | 0.20   |

Notes:

Results in mg/l except pH-value and conductivity ( $\mu\text{S}/\text{cm}$ ).

Source: UK Department of the Environment (1995)

## 7.2 LEACHATE VOLUMES AND QUALITY

### 7.2.1 WATER BALANCE

A knowledge of the likely leachate generation of a landfill is a prerequisite to the planning of a leachate management strategy. An assessment of the leachate generation rate cannot be prepared in the absence of a phasing plan. An understanding of the likely potential for leachate generation is essential at the conceptual design stage. Water balances are used to assess likely leachate generation volumes. Parameters used include waste volumes, input rates and absorptive capacity, effective and total rainfall, infiltration and other site parameters.

As the landfill design progresses, the calculations should be refined. As a minimum, a simple water balance calculation should be undertaken twice yearly, to check whether there has been any increase in leachate production. The calculation should be of the form:

$$Lo = [ER(A) + LW + IRCA + ER(l)] - [aW]$$

where:

- Lo = leachate produced (m<sup>3</sup>)
- ER = effective rainfall (use actual rainfall (R) for active cells) (m)
- A = area of cell (m<sup>2</sup>)
- LW = liquid waste (also includes excess water from sludges) (m<sup>3</sup>)
- IRCA = infiltration through restored and capped areas (m)
- l = surface area of lagoons (m<sup>2</sup>)
- a = absorptive capacity of waste (m<sup>3</sup>/t)
- W = weight of waste deposited (t/a)

The output of a typical water balance calculation (for illustrative purposes only) is given in Table 7.3.

Two uses for water balance calculations are:

- to design the leachate collection and treatment systems; and
- to design sizes of cells.

The parameters used in the water balance calculation are outlined below. Further refinement of the water balance may include taking account of factors such as moisture losses via landfill gas and waste fermentation, for further information see Knox, 1991.

### Effective Rainfall

Effective Rainfall (ER) is defined as Total Rainfall (R) minus Actual Evapotranspiration (AE) i.e.  $ER=R-AE$ . For individual landfills it is common practice to estimate rainfall by using data from the nearest Meteorological Office weather station or rainfall gauging stations. Rainfall estimations at automatic weather stations themselves are accurate to 5% (Met Eireann, 1997). It should be noted that rainfall can vary significantly over quite short distances. Individual rainfall events, such as summer thunderstorms can be very localised. Differences in elevation between the landfill site and the gauging station can lead to systematic errors in estimating R. Errors in annual estimates of R from these sources may be in the order of 10% and for individual rainfall events may exceed 20%.

Evaporative losses are a combination of evaporation of water from the surface and transpiration of water by plants where vegetation is present. Transpiration due to vegetation can effectively be ignored for the purposes of water balance calculations on uncompleted landfills. In any event, evapotranspiration is difficult to predict on a daily basis and the Potential Evapotranspiration (PE) could be overestimated during winter months by up to 20mm/month, or underestimated by more than 60-160mm/a. Consequently, evaporative losses may be ignored to provide a safety factor in the water balance calculations. A wider discussion on effective rainfall and its effect on water balances is described elsewhere (Knox, 1991).

For water balances carried out on active phases of landfills, it is assumed that all the Actual Rainfall will infiltrate into the waste. In areas that have been temporarily capped/restored an infiltration rate of 25-30% of the annual rainfall should be used. Infiltration in restored areas would be in the range 2-10% of ER in a worst case scenario for a geosynthetic clay liner cap. Infiltration into restored areas should be calculated using site specific information.

TABLE 7.3: TYPICAL WATER BALANCE CALCULATION

| Year | Active Phase | Active Area<br>A (m <sup>2</sup> ) | (1) Active area infiltration<br>R(A) (m <sup>3</sup> ) | Restored Phase No. | (2) Liquid Waste<br>LW (m <sup>3</sup> ) | Restored area<br>RCA (m <sup>2</sup> ) | (3) Restored area infiltration<br>IRCA (m <sup>3</sup> ) | Total Water<br>(1) + (2) + (3) (m <sup>3</sup> ) | Cumulative water<br>Σ (1) + (2) + (3) (m <sup>3</sup> ) | Absorptive Capacity<br>aW (m <sup>3</sup> ) | Cumulative Absorptive Capacity<br>Σ aW (m <sup>3</sup> ) | Cumulative Leachate<br>Σ Lo (m <sup>3</sup> ) | Leachate Produced<br>Lo (m <sup>3</sup> ) |
|------|--------------|------------------------------------|--|--------------------|--|--|--|--|---|---|--|---|---|
| 1    | 1            | 17000                              | 19261  |                    | 0  | 0                                      | 0  | 19261  | 19261   | 500   | 500  | 18761   | 18761                                     |
| 2    | 2            | 28000                              | 31724  | 1                  | 0  | 12000                                  | 737  | 32461  | 51722   | 500   | 1000   | 50722   | 31961                                     |
| 2    | 2            | 28000                              | 31724  | 1                  | 0  | 12000                                  | 737  | 32461  | 84183   | 500   | 1500   | 82683   | 31961                                     |
| 3    | 3            | 27000                              | 30591  | 1,2                | 0  | 34000                                  | 2088   | 32679  | 116861  | 500   | 2000   | 114861  | 32179                                     |
| 5    | 3            | 27000                              | 30591  | 1,2                | 0  | 34000                                  | 2088   | 32679  | 149540  | 500   | 2500   | 147040  | 32179                                     |
| 6    | 4            | 28000                              | 31724  | 1,2,3              | 0  | 55000                                  | 3377   | 35101  | 184641  | 500   | 3000   | 181641  | 34601                                     |
| 7    | 4            | 28000                              | 31724  | 1,2,3              | 0  | 55000                                  | 3377   | 35101  | 219742  | 500   | 3500   | 216242  | 34601                                     |
| 8    | 5            | 30000                              | 33990  | 1,2,3,4            | 0  | 76000                                  | 4666   | 38656  | 258398  | 500   | 4000   | 254398  | 38156                                     |
| 9    | 5            | 30000                              | 33990  | 1,2,3,4            | 0  | 76000                                  | 4666   | 38656  | 297055  | 500   | 4500   | 292555  | 38156                                     |
| 10   | 5            | 30000                              | 33990  | 1,2,3,4            | 0  | 76000                                  | 4666   | 38656  | 335711  | 500   | 5000   | 330711  | 38156                                     |
| 11   | 6            | 28000                              | 31724  | 1,2,3,4,5          | 0  | 98000                                  | 6017   | 37741  | 373452  | 500   | 5500   | 367952  | 37241                                     |
| 12   | 6            | 28000                              | 31724  | 1,2,3,4,5          | 0  | 98000                                  | 6017   | 37741  | 411193  | 500   | 6000   | 405193  | 37241                                     |
| 13   | 6            | 28000                              | 31724  | 1,2,3,4,5          | 0  | 98000                                  | 6017   | 37741  | 448935  | 500   | 6500   | 442435  | 37241                                     |
| 14   | 6            | 28000                              | 31724  | 1,2,3,4,5          | 0  | 98000                                  | 6017   | 37741  | 486676  | 500   | 7000   | 479676  | 37241                                     |
| 15   | 7            | 22000                              | 24926  | 1,2,3,4,5,6        | 0  | 118000                                 | 7245   | 32171  | 518847  | 500   | 7500   | 511347  | 31671                                     |
| 16   | 7            | 22000                              | 24926  | 1,2,3,4,5,6        | 0  | 118000                                 | 7245   | 32171  | 551018  | 500   | 8000   | 543018  | 31671                                     |
| 17   | 7            | 22000                              | 24926  | 1,2,3,4,5,6        | 0  | 118000                                 | 7245   | 32171  | 583189  | 500   | 8500   | 574689  | 31671                                     |
| 18   | 8            | 27000                              | 30591  | 1,2,7              | 0  | 133000                                 | 8166   | 38757  | 621947  | 500   | 9000   | 612947  | 38257                                     |
| 19   | 8            | 27000                              | 30591  | 1,2,7              | 0  | 133000                                 | 8166   | 38757  | 660704  | 500   | 9500   | 651204  | 38257                                     |
| 20   | 8            | 27000                              | 30591  | 1,2,7              | 0  | 133000                                 | 8166   | 38757  | 699461  | 500   | 10000  | 689461  | 38257                                     |
| 21   | 8            | 27000                              | 30591  | 1,2,7              | 0  | 133000                                 | 8166   | 38757  | 738218  | 500   | 10500  | 727718  | 38257                                     |
| 22   | Restored     | 0                                  | 0  | 1,2,8              | 0  | 160000                                 | 9824   | 9824   | 748042  | 0   | 10500  | 737542  | 9824                                      |
| 23   | Restored     | 0                                  | 0  | 1,2,8              | 0  | 160000                                 | 9824   | 9824   | 757866  | 0   | 10500  | 747366  | 9824                                      |
| 24   | Restored     | 0                                  | 0  | 1,2,8              | 0  | 160000                                 | 9824   | 9824   | 767690  | 0   | 10500  | 757190  | 9824                                      |
| 25   | Restored     | 0                                  | 0  | 1,2,8              | 0  | 160000                                 | 9824   | 9824   | 777514  | 0   | 10500  | 767014  | 9824                                      |
| 26   | Restored     | 0                                  | 0  | 1,2,8              | 0  | 160000                                 | 9824   | 9824   | 787338  | 0   | 10500  | 776838  | 9824                                      |
| 27   | Restored     | 0                                  | 0  | 1,2,8              | 0  | 160000                                 | 9824   | 9824   | 797162  | 0   | 10500  | 786662  | 9824                                      |
| 28   | Restored     | 0                                  | 0  | 1,2,8              | 0  | 160000                                 | 9824   | 9824   | 806986  | 0   | 10500  | 796486  | 9824                                      |
| 29   | Restored     | 0                                  | 0  | 1,2,8              | 0  | 160000                                 | 9824   | 9824   | 816810  | 0   | 10500  | 806310  | 9824                                      |
| 30   | Restored     | 0                                  | 0  | 1,2,8              | 0  | 160000                                 | 9824   | 9824   | 826634  | 0   | 10500  | 816134  | 9824                                      |

Note: Actual rainfall is 1133 mm per annum. Effective rainfall is 614mm per annum - 10% of which infiltrates the restored areas. No liquid effluent accepted. It is estimated that the landfill will accept 20,000 tonnes per annum over 21 years, the waste density is 1 tonne/m<sup>3</sup> and the absorptive capacity is 0.025m<sup>3</sup>/m<sup>3</sup>. (adapted from UK Department of the Environment, 1995).



### Liquid Wastes

Council Directive *on the landfill of waste* (99/31/EC) requires Member States to prohibit the acceptance of liquid waste, meaning any waste in liquid form including waste waters but excluding sludge, to landfill.

It is estimated that over 100,000 total tonnes dry solids of urban waste water sludges will be produced in Ireland by the year 2000 (*'Strategy Study on Options for the Treatment and Disposal of Sewage Sludge in Ireland', 1993*). Although it is suggested that land and forest application are among the favoured disposal options it is likely that landfilling (the least desired option) will be utilised.

The Directive on the landfill of waste requires that only sludges that have been subjected to some form of pre-treatment may be accepted at landfills. Much of the sludge produced is only about 1% dry solids when it is first produced. There are over 40 sludge treatment technologies available worldwide the most common including: (i) thickening/dewatering, (ii) anaerobic digestion, (iii) aerobic digestion, and (iv) lime treatment. Experience in the European context has found that only sludges with a dry solids content of greater than 20% can be landfilled. This is only achievable by use of dewatering equipment such as plate presses or centrifuges. Other approaches include limiting the quantity of sludge accepted to less than 10% of total waste intake.

The percentage solids in the sludge must be taken into account when performing the water balance.

### Waste Input

The rate of waste input will be required in order to complete the water balance calculation. Consideration should be given to the nature of the waste and the input rate which will vary during the active life of the landfill.

### Absorptive Capacity

The amount of water that can be absorbed without generating leachate depends on the type of waste, its initial moisture content and the density to which it is compacted. For example, for a waste density of 0.65 t/m<sup>3</sup> the waste is capable of absorbing a further 0.1m<sup>3</sup> water per tonne of waste before leachate is generated. This absorptive capacity falls to about 0.025m<sup>3</sup> water per tonne of waste for waste densities of 1 t/m<sup>3</sup>.

FIGURE 7.3: RELATIONSHIP BETWEEN WASTE DENSITY AND THE ABSORPTIVE CAPACITY OF WASTE

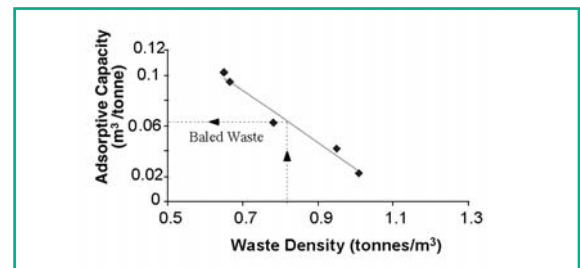

Such figures ignore the potential short-circuiting by preferential pathways through waste and the effects of high rainfall intensity.

Greater absorption may be achieved by recirculation of the leachate.

### Accuracy of Water Balance Calculations

The accuracy of calculations will depend on the methodology used and on the sources of data. Each is subject to errors in estimation. In an operational landfill or even a completed landfill with leachate data available, it may be difficult to estimate volumes to better than a factor of 2 (Knox, 1991). However on site measurements of leachate quantities will guide calculations.

### Water Balance

Water balance calculations should be carried out for a number of scenarios such as average monthly leachate volumes to be generated, the maximum quantity of leachate generated during development using 2 and 5 day rainfall events with 10 and 25 year return periods. These calculations will assist in predicting the likely rate of leachate generation.

However, site conditions will influence the actual rate of generation and a peak flow factor of 3 to 5 times the predicted average flow rate should be used when sizing plant/pipework.

### 7.2.2 CONTROLLING LEACHATE PRODUCTION

It is now accepted best practice to operate landfill sites on the basis of containment to prevent leachate polluting groundwater and also to avoid problems of landfill gas migration. Creating a site with a high degree of containment, however, may result in the accumulation of leachate at the base of the site. As the head of leachate builds there is an increased risk of leakage. In addition, gas extraction becomes more difficult as the depth of the unsaturated waste layer decreases. Hence there is a need to remove the leachate from the base of the site and to treat it in an environmentally acceptable manner.

In order to reduce the cost of leachate extraction and treatment, landfill sites should be operated so as to minimise the volumes of leachate produced.

## 7.3 LEACHATE COLLECTION AND REMOVAL SYSTEM

### 7.3.1 INTRODUCTION

An effective leachate collection and removal system (LCRS) is a prerequisite for all non-hazardous and hazardous landfill sites. An inert landfill that implements strict waste acceptance criteria may not require an LCRS. The purpose of the leachate collection layer is to allow the removal of leachate from the landfill and to control the depth of the leachate above the liner. The leachate collection system must function over the landfill's design lifetime irrespective of the liquids management strategy being used.

The LCRS is a component of the landfill liner system and the reader should read this Section in conjunction with the recommendations on liner systems in Chapter 6.

The leachate management system should include the following components:

- a drainage layer (blanket) constructed of either natural granular material (sand, gravel) or synthetic drainage material (e.g. geonet or geocomposite). Synthetic drainage material may be used on sidewalls of the landfill cells, where the construction and operation of granular material may be difficult;

- perforated leachate collection pipes within the drainage blanket to collect leachate and carry it to a sump or collection header pipe;
- a protective filter layer over the drainage blanket, if necessary, to prevent physical clogging of the material by fine grained material;
- leachate monitoring point(s); and
- leachate collection sumps or header pipe system where leachate can be removed.

Figure 7.4 illustrates a typical leachate collection system.

FIGURE 7.4: TYPICAL LEACHATE COLLECTION AND REMOVAL SYSTEM

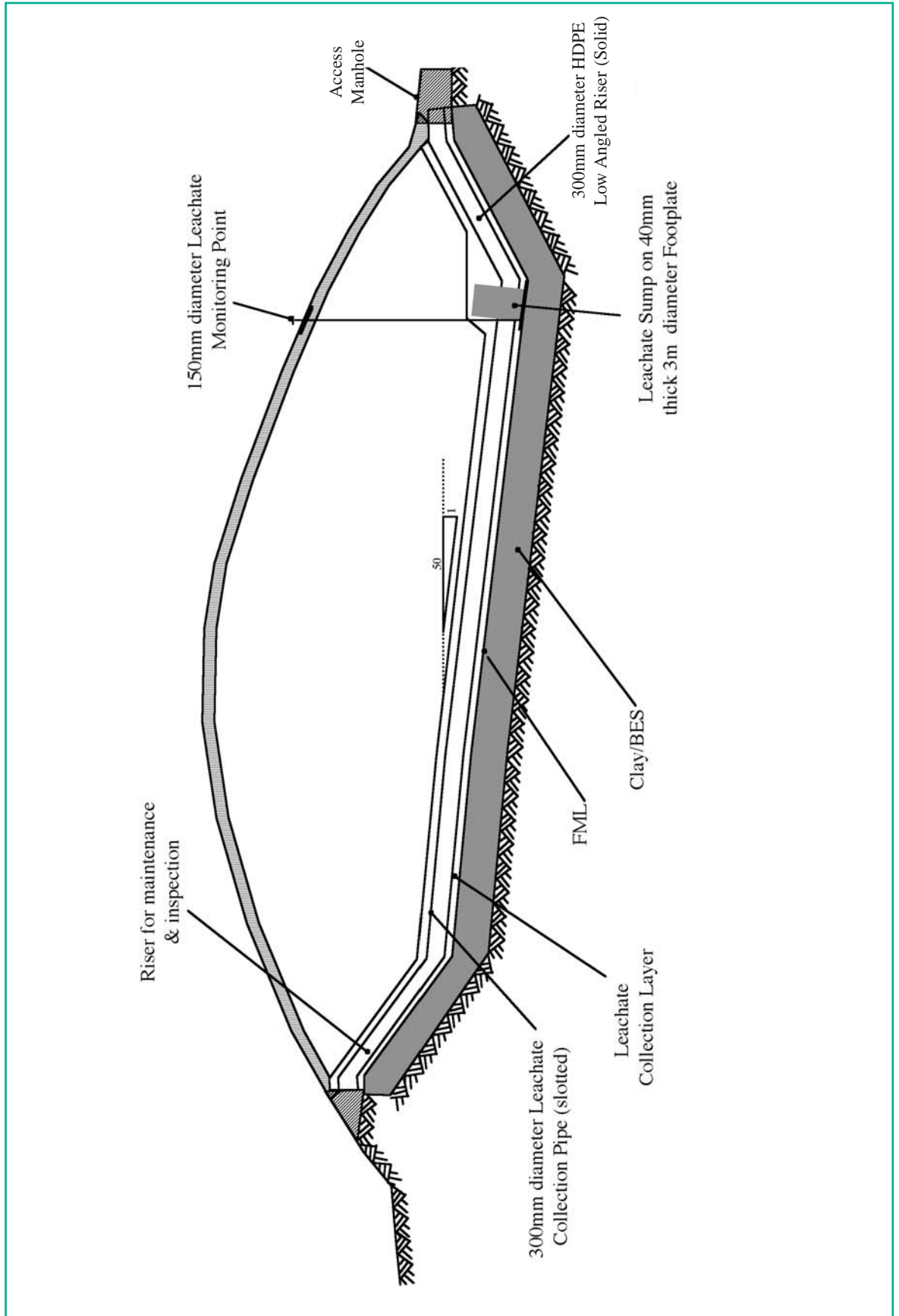

### 7.3.2 DESIGN FEATURES AND RECOMMENDED MINIMUM STANDARDS

The leachate collection system should be designed to minimise the head of leachate above the liner. The leachate head is a function of leachate generation, bottom slope, pipe spacing, and hydraulic conductivity of the drainage blanket.

#### Basal shape

The base of cells should be sloped to facilitate gravitational flow of leachate to sumps or leachate header pipes.

- minimum fall of 2% towards leachate collection sump, this gradient also promotes self cleansing and reduces blockages in the leachate collection pipe(s); and
- the gradient towards the main leachate collection pipe(s) should at minimum be 1%.

#### Drainage blanket

- thickness 500mm with minimum hydraulic conductivity of  $1 \times 10^{-3}$  m/sec;
- drainage media to be rounded, pre-washed non calcareous stone (less than 10%  $\text{CaCO}_3$ ), unless site specific tests prove otherwise;
- particle size to be compatible with the proposed geomembrane. See article on 'Protection and backfilling' under Section 6.6.3;
- drainage blanket to have documented durability and mechanical strength commensurate with the proposed loading; and
- consideration should be given to standard aggregate tests (e.g. Slake Durability Test BS 882, Acid Immersion Test, Magnesium Sulphate Soundness Test).

#### Leachate Drainage Pipes

The drainage layer piping is the component that is most vulnerable to compressive strength failure. The design of leachate collection pipes should consider:

- required capacity and pipe spacing;
- pipe size and maximum slope; and
- structural strength of the pipe.

The leachate collection pipes should at minimum meet the following requirements:

- a network of perforated smooth bore 200 mm minimum diameter (generally high density polyethylene, or polypropylene) laid to a self cleansing gradient;
- intake area of at least  $0.01\text{m}^2/\text{m}$  length of pipe;
- their crush strength should be commensurate with the imposed waste loading and operating equipment; and
- should not be susceptible to chemical attack by the leachate.

The pipe spacing may be determined by the mound model. In the Mound Model (see Figure 7.5), the maximum height of fluid between two parallel perforated drainage pipes is equal to (U.S. EPA, 1989):

$$h_{\max} = \frac{L/c}{2} \left[ \frac{\tan^2 \alpha}{c} + 1 - \frac{\tan \alpha}{c} \sqrt{\tan^2 \alpha + c} \right]$$

where:

- $h_{\max}$  = maximum allowable head on the liner
- $c = q/K$
- $q$  = inflow rate
- $K$  = permeability
- $\alpha$  = slope

The 2 unknowns in the equation are:

- $L$  = distance between the pipes and
- $c$  = amount of leachate.

The estimated amount of leachate generated can be obtained from the water balance calculations. The equation can then be solved to calculate the spacing of pipes.

Protection of the installation during the early stages of waste deposition is considered to be of paramount importance since this is the time when it is most vulnerable to damage. Consequently, it is advised that the first 2 metres of waste, free of bulky or sharp objects, are left uncompacted above the drainage blanket. This will not only protect it from equipment damage but also will enhance drainage in the lower regions of the waste and provide extra filtering for suspended material being transported by leachate.

FIGURE 7.5: MOUND MODEL TO DETERMINE PIPE SPACING

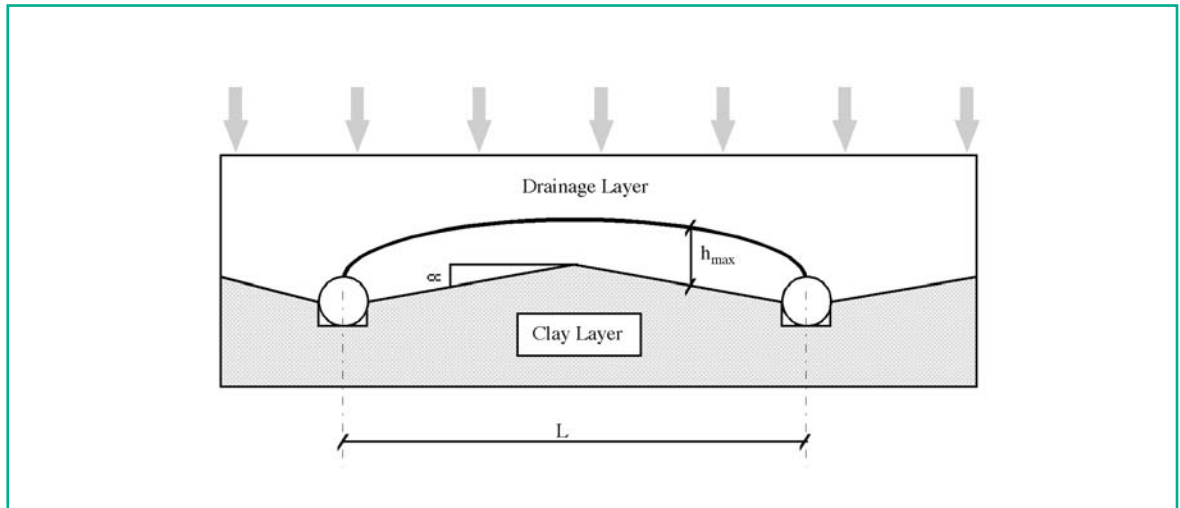

### 7.3.3 SOURCES OF CLOGGING

The most common reason for failure in the drainage system is clogging, i.e. the physical build-up of material in pipes, drainage layer or filter layer. Other less common reasons are deterioration through corrosion and system overload. Clogging may be caused by solid, biological organisms, chemical or biochemical precipitations or combinations of all four (see Table 7.4). It may be caused by the incoming particulates being larger than the void spaces in the filter. Within pipes, accumulations of deposits may be induced because of inadequate localised flows caused by too low a slope or by areas of hydraulic perturbation such as pipe joints being poorly installed, or by elbows and intersections. Such sedimentation is a common cause of clogging.

Biological clogging is caused by interstitial growth of microorganisms in the presence of oxygen, appropriate nutrients, growth conditions and energy sources. The factors that primarily influence growth include: (i) carbon : nitrogen ratio in the leachate, (ii) presence/absence of oxygen, (iii) nutrient supply, (iv) concentration of polyuronides, (v) temperature.

Chemical precipitation can be formed when pH levels exceeds 7 (although to a lesser extent above pH 5) but are also dependent upon the hardness and the total alkalinity of the leachate. Other factors that can cause precipitation include the presence of oxygen, changes in the partial pressure of  $\text{CO}_2$  and evaporation of residual fluid. The most common precipitate is of calcium carbonate but others are manganese carbonate and manganese sulphides and silicates.

Biochemical precipitation can also lead to clogging problems. The principal biochemical precipitates are  $\text{Fe}(\text{OH})_3$  and  $\text{FeS}$  although manganate compounds may also be involved. This process (for iron) depends on (i) the availability of dissolved (free) ions (influenced by redox potential, pH and complexing agents), (ii) the presence of iron reducing bacteria. The precipitate is generally mixed with a biological slime that is quite adherent and can block flow through a drainage system. Precipitates produced as a result of biochemical activity are generally quite different in form and structure from those resulting from chemical processes alone and may show a greater tendency to clogging which is apparent in the case of adherence to plastic piping.

TABLE 7.4: CHARACTERISTICS OF LEACHATE THAT ARE POTENTIAL CLOGGING MECHANISMS

| Potential Clogging Mechanism | Leachate Parameter of Concern  |
|------------------------------|--|
| Particulate                  | pH, total solids, TDS, TSS   |
| Biological                   | pH, COD, BOD, TOC, Total N, Total P  |
| Precipitate                  | pH, Conductivity, alkalinity, hardness ( $\text{CaCO}_3$ ), Ammonia, Total P, $\text{NO}_3$ , Ca, Cl, Na, $\text{SO}_4$ , Mn, Mg |
| Biochemical                  | pH, Iron, Manganese  |

### 7.3.4 PREVENTATIVE MEASURES TO REDUCE CLOGGING

It is recommended that the leachate collection and removal system be kept anaerobic for the following reasons:

- reduced clogging may be expected under anaerobic rather than aerobic conditions;
- there is less microbial aggregations and slimes produced under anaerobic conditions; and
- chemical precipitation of carbonates, sulphates and iron oxides which can commonly cause clogging is much less prevalent under anaerobic and reduced conditions.

It is recommended that air be excluded from the leachate collection and removal system. At sites where the base of the cell is designed to be drained of all leachate, this may be done by leachate removal via a permanently wet sump. Maintenance of a limited leachate head to ensure that the leachate collection system is permanently saturated would also have this effect.

In addition, the system design should include features that allow for pipe system cleanings. The components of the cleaning system should include:

- a minimum of 200mm diameter pipes to facilitate cleaning;
- access located at major pipe intersections or bends to allow for inspections and cleaning; and
- valves, ports, or other appurtenances to introduce biocides and/or cleaning solutions.

### 7.3.5 LEACHATE REMOVAL

Leachate can be removed from the landfill through leachate collection sumps or via a leachate collection header pipe system. A number of various removal systems exist with the main options as follows:

- a sump with a manhole extension rising vertically through the waste and final capping system. The sump is made either *in situ* or prefabricated off site. The vertical riser is either a concrete or plastic standpipe. It is extended as the waste is placed in the facility;
- a sump with a solid wall pipe riser coming up the side slope where it eventually penetrates the final capping system (Figure 7.6); and

- leachate header pipe, gravity draining, extending through and penetrating the liner system to a location beyond the landfill cell area.

It is recommended that a sump system with the vertical riser or the side wall riser should be used either separately or in combination. When used in combination it facilitates maintenance.

#### Liner Penetration

Penetration of the basal liner system should be avoided where possible. However, for double lined hazardous waste facilities, if penetration of the primary liner is the preferred option, it should occur close to the top side slope of the cell away from the maximum leachate head (shown in the schematic of Figure 7.7(a)). Penetration of the secondary liner should allow any leachate detected to flow by gravity to an exterior manhole or sump (Figure 7.7(b)). A high degree of care should be exercised in both the design and construction of the penetration. The penetration should be designed and constructed in a manner that allows nondestructive quality control testing of the seal between the pipe and the geomembrane.

#### Sumps

Sumps are located at low points in cells to allow gravitational drainage of leachate. Leachate is removed from the sumps by pumping. In the past, low volume sumps have been constructed successfully from reinforced concrete pipe on a concrete footing (typically minimum 1m diameter). More recently high density polyethylene pipes have been used, welded to a thick HDPE baseplate using a series of supporting webs. The minimum size should be approximately 300mm to facilitate pump insertion if necessary. These structures (HDPE) may be suitable for replacing the concrete components of the sump and have the advantage of being lighter in weight.

#### Vertical Chambers

Vertical leachate collection chambers should be surrounded by a permeable drainage media, not deposited wastes, to assist in vertical percolation of leachate to the chamber. Figure 7.8 shows the general arrangement for a leachate pumping chamber. Consideration should be given to installing telescopic HDPE manhole shafts where the waste height will be extensive and the stresses on the shaft due to settlement could cause collapse of the shaft.



### Sidewall pipes

The use of low angled leachate risers which are laid parallel to the side of the site should be considered. These act as alternatives to the traditional leachate chambers illustrated earlier. Although not suitable for sites with steep sides, the system exerts much lower pressures on the liner system. A second advantage is that vertical chambers often suffer from sideways movement due to settlement although the effects of this can be reduced/mitigated by the adoption of telescopic HDPE shafts. The low angle riser system is less prone to damage from the filling process as they are located at the perimeter of the phase.

### Pumps

Pumps used to remove leachate from the sumps should be sized to ensure removal of leachate at the maximum rate of generation. These pumps should have a sufficient operating head to lift the leachate to the required height from the sump to the access port.

There are three common pump types used:

- eductor pumps (hydraulic);
- ejector pumps (pneumatic); and
- submersible pumps.

Pumps should exhibit the following characteristics:

- easy to install and remove;
- be of robust manufacture;

- minimum moving parts;
- low maintenance requirements;
- capable of variable flow rate, as conditions will vary throughout the seasonal cycle. A range from about 60 litres an hour to greater than 1m<sup>3</sup>/hr would be realistic for a pump located within a borehole;
- capable of running dry with no harm being done to its operation;
- capable of handling varying quantities of fine material and sludge that often accompanies leachate production, perhaps with additional protection being afforded by filtration; and
- it must have sufficient head.

### Eductor pumps

This system involves circulating leachate down and through an eductor nozzle. The increased velocity through the nozzle creates a suction effect inducing additional leachate into the flow. Eductor pumps may vary in size from as little as 1m<sup>3</sup>/hr to units capable of extracting several hundreds of cubic metres per hour.

Advantages:

- no expensive moving parts;
- low maintenance; and
- inexpensive to install.

FIGURE 7.6: LEACHATE COLLECTION SUMP AND PIPE RISER GOING UP THE SIDE SLOPE

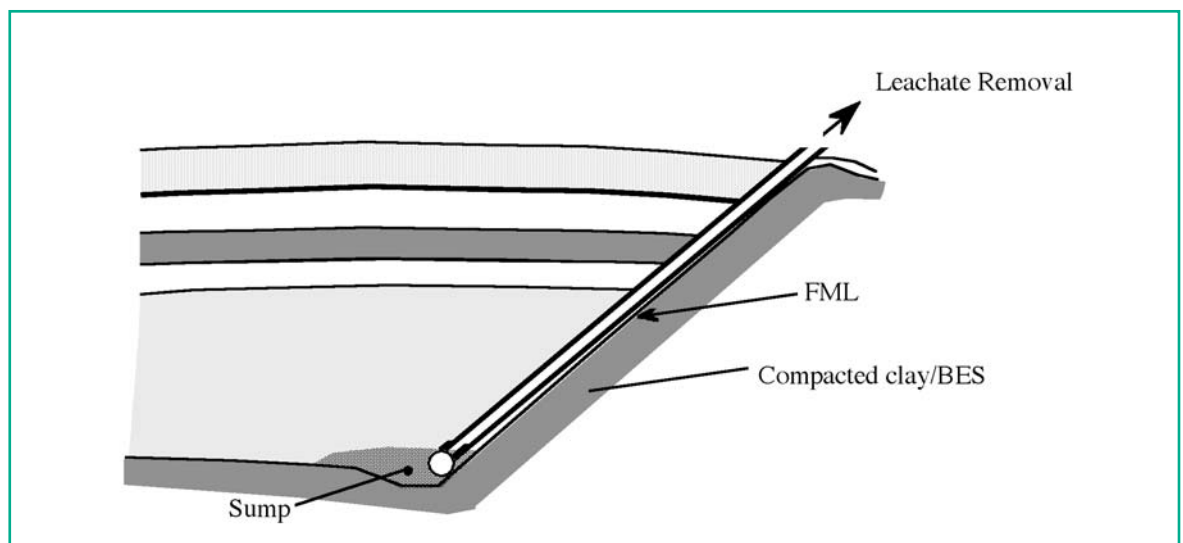

**FIGURE 7.7: SECONDARY LEAK DETECTION REMOVAL SYSTEMS (HAZARDOUS LANDFILLS ONLY)**

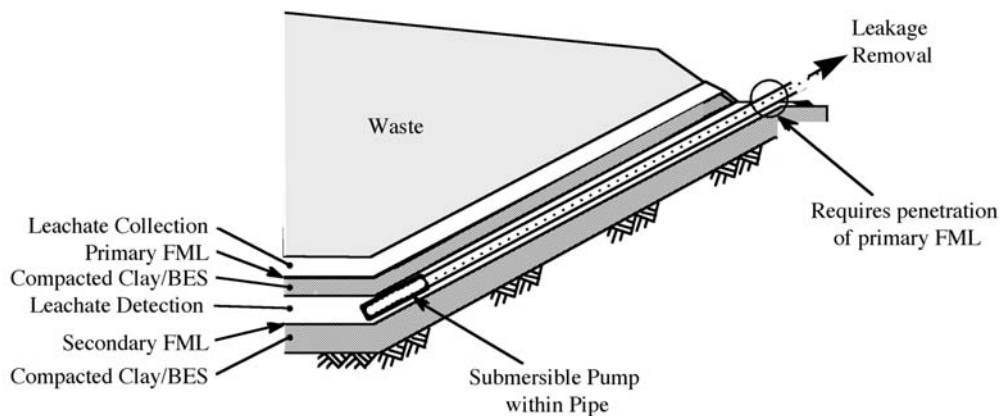

**(a) Leak Detection Removal System via pumping between liners and penetration of primary liner**

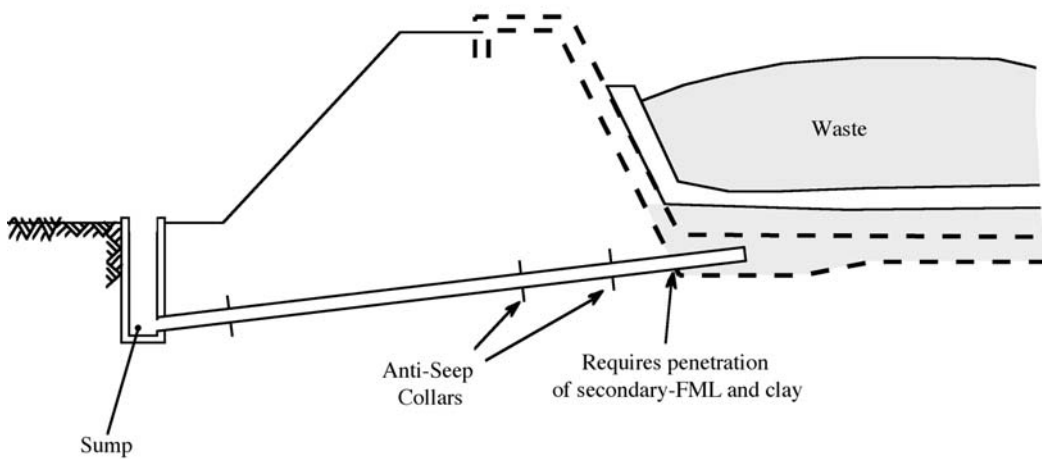

**(b) Leak Detection Removal System via gravity monitoring via penetration of secondary liner**



FIGURE 7.8: GENERAL ARRANGEMENT OF LEACHATE PUMPING CHAMBER

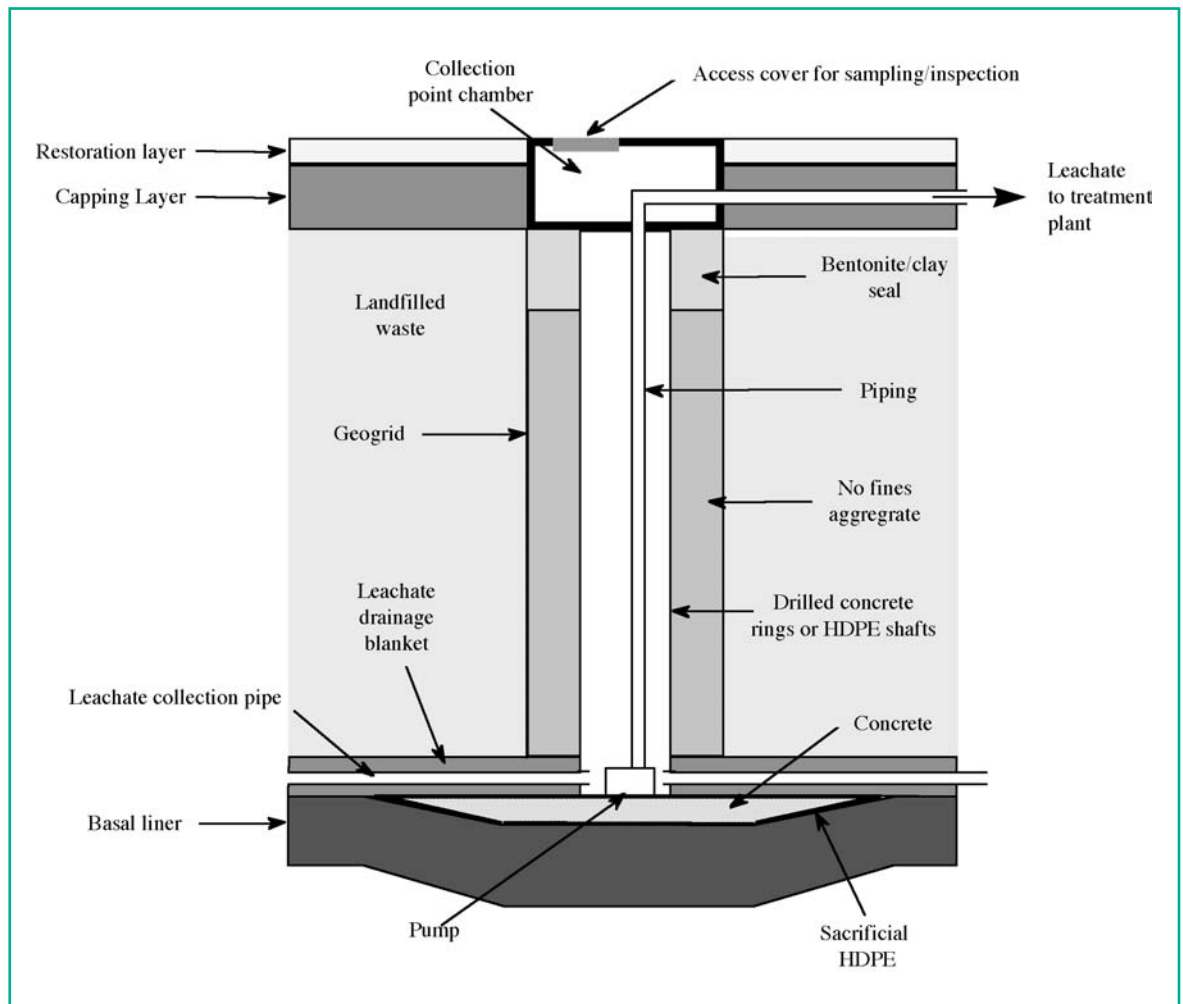

## Disadvantages:

- may be expensive to operate.

*Ejector pumps*

Note that ejector pumps are also known as eductor pumps and the difference between those presented is hydraulic versus pneumatic. Pneumatic ejector pumps use an intermittent pressurised air supply to force leachate out of a vessel. The vessel is fitted with check valves and the appropriate connections to allow leachate to flow in, then to allow pressurised air to force the leachate out. Pneumatic ejector pumps may operate in the range of 0-30m<sup>3</sup>/d per well.

## Advantages:

- low air input which is used on as required basis; and
- low maintenance.

## Disadvantages:

- higher per unit installation cost.

*Submersible pumps*

The pump is directly connected to an electric motor sited immediately below it.

## Advantages:

- quick and easy to install.

## Disadvantages:

- needs to be immersed in leachate, should it run dry the unit will fail rapidly; and
- leachate can cause significant wear of moving parts.

### Leachate collection and removal system maintenance

The leachate collection and removal system should be maintainable. This can be achieved by the inclusion of rodding ports in the design of the system. The main access will be through the leachate sump access pipe. This allows for the installation of a rodding point at the surface so that the pipework can be cleared of blockages and facilitates access for CCTV inspection.

Methane levels in pumping chambers and collection pipes must be monitored and venting should be provided where necessary. All pumps should be intrinsically safe, whilst any monitoring equipment should not be able to cause sparks within any closed spaces. For example, it is undesirable that steel balers are used to sample in leachate chimneys (Landfill Operational Practices Manual, EPA, 1997).

#### 7.3.6 MONITORING OF LEACHATE IN LANDFILL

Monitoring is required to ensure the leachate head is being successfully controlled. A minimum of two monitoring points should be provided in all cells. Each cell should be monitored at its leachate collection point, which is the lowest point in the cell and at two additional locations per hectare of cell area. The precise location of these observation points will be decided on a site specific basis, but they should be located taking into account the likely flow-paths of the leachate within the cell, so as to provide samples representative of the average composition of the leachate and measurements of leachate head. Figure 7.9 provides typical leachate monitoring well details.

The minimum requirements for monitoring the level, volume and composition of leachate at landfill sites are set out in the Agency's Landfill Manual '*Landfill Monitoring*'.

### 7.4 LEACHATE STORAGE

Storage facilities for leachate may take the same form as those identified in Section 5.3.1 for stormwater retention:

- concrete tanks designed to BS8007;
- prefabricated units; and
- geosynthetic lined, e.g. HDPE lined facilities.

Such facilities should be sized to accommodate the leachate volume calculated under Section 7.2 and should be designed to prevent overtopping.

All units should be designed to prevent leakages. When using concrete tanks or prefabricated units consideration should be given to the provision of storage bunds (refer to guidance in Appendix A). In situations where it is proposed to line the storage facility with a geosynthetic material the design/construction and associated quality control/assurance should follow the general guidance given under Chapter 6 *Lining Systems*.

A storage lagoon for leachate from a non-hazardous landfill may consist of the following composite liner:

- the upper component of the composite liner may consist of a flexible membrane liner. At minimum a 2mm HDPE or equivalent flexible membrane liner should be used; and
- the lower component of the composite liner may consist of a 1m layer of compacted soil with a hydraulic conductivity of less than or equal to  $1 \times 10^{-9} \text{m/s}$  constructed in a series of compacted lifts no thicker than 250mm when compacted or a 0.5m artificial layer of enhanced soil giving equivalent protection to the foregoing also constructed in a series of compacted lifts no thicker than 250mm when compacted.

A storage lagoon for leachate from a hazardous landfill may consist of a similar lining system to that of a non-hazardous landfill (the flexible membrane however needs to be compatible with the leachate) but provision to detect any leakages should be made in the design.

The integrity of the liner system for a storage lagoon should be checked prior to emplacement of leachate through the use of leak detection surveys (see Section 6.7) and liquid retention tests. These surveys may need to be repeated during the operational life of the lagoon. The time interval of such surveys will be site specific.

### 7.5 RECIRCULATION OF LEACHATE

Leachate recirculation is practiced at a significant proportion of landfills in many countries (e.g. approximately 30% of MSW sites in Denmark). So far it has not been done for the purposes of increasing the flushing rate but mainly to promote more uniform degradation rates and as a short term leachate storage measure.

The potential benefits of leachate recirculation are listed below:

- increased quantity and quality of landfill gas for use in energy recovery projects;
- reduction in the cost of leachate collection and disposal;
- enhancement of landfill settlement and possible opportunity to recover air space; and
- early stabilisation of the landfill leading to reduced postclosure time and cost.

The final item on the list, early landfill stabilisation and control of closure costs, is probably the major driving incentive for owner/operators to pursue recirculation. The post closure or aftercare periods required under current legislation create a significant potential liability for owners.

There are some concerns about implementing a recirculation programme at an operating landfill.

These include:

- operating landfills are difficult environments for in-fill recirculation systems components;
- typical operations require heavy equipment such as scrapers, dozers and compactors moving across the active area of the landfill. The view from the operators seat is such that they cannot often see vertical obstructions such as manholes or settlement plate access tubes. Heavy equipment loading may also tend to crush piping system components that are installed as filling progresses;
- there is some concern that the initial result of leachate recirculation will be an increase in the concentration of contaminants that may preclude utilisation of existing agreements with municipal wastewater treatment plants;
- possibility of increased leachate heads on the lining system; and
- leachate outbreaks along above ground side-slopes are a perennial concern for landfill operators. Many operators are concerned that recirculation may exacerbate the problem with outbreaks, particularly if a relatively impermeable daily cover was used during construction of the landfill.

### **Prerequisites of an effective leachate recirculation system**

No recirculation should be carried out unless an appropriate lining system and leachate collection system is in place.

For proper execution of leachate recirculation, the following components are generally considered to be necessary:

- a leachate reintroduction system contained within the landfill enclosure;
- a composite lining system with a leachate handling system that demonstrates a minimum of 6 months acceptable liner performance (where for existing lined sites that groundwater monitoring verifies no landfill induced contamination);
- an adequate monitoring system for determining the level of leachate in the waste;
- provisions for run off collection and containment must be provided on areas where any soil cover has been applied; and
- trained landfill operators that understand the operational requirements of leachate recirculation.

When acetogenic leachate is being generated it may be preferable to pre-treat extracted leachate through an aerobic treatment process before recirculation. This limits the buildup of inhibitory contaminants such as ammonia, and especially very acidic leachates which prevent the rapid establishment of neutral pH conditions conducive to methanogenic conditions. If "fresh" leachates are to be directly re-injected, it may be advantageous to incorporate a pH buffer to maintain a methanogenic (near neutral conditions). While these options may be speculative, they are considered practicable even though increased landfill costs are attached. Nonetheless the potential savings in reduced operation of leachate systems where waste stabilisation periods are substantially reduced.

There is little design information available in the literature regarding leachate application rates. Miller *et al.*, (1994), reported leachate application rates of 0.31-0.62m<sup>3</sup>/m of trench length per day at 14 to 23 m<sup>3</sup>/hr.

FIGURE 7.9: TYPICAL LEACHATE MONITORING CHAMBER DETAILS

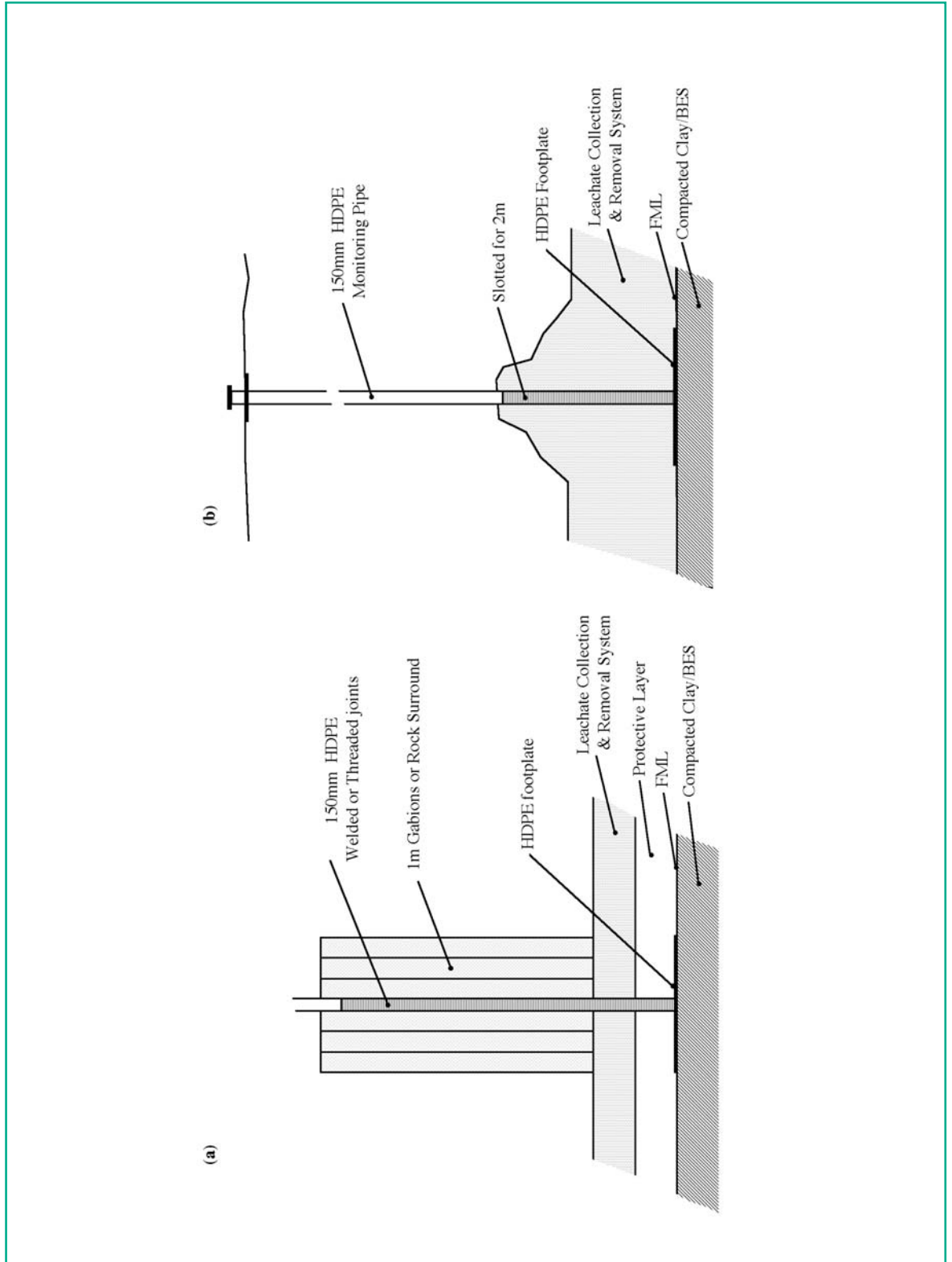

## 8. LEACHATE TREATMENT

### 8.1 INTRODUCTION

The main constituents of leachate requiring treatment are the ammoniacal content and the organic constituent of the leachates. Treatment methods may be divided into four categories:

- Physical/chemical pre-treatment;
- Biological treatment;
- Combination of 1 and 2 in one system; and
- Advanced Treatment.

Table 8.1 provides a summary of leachate treatment methods and objectives.

### 8.2 PHYSICAL - CHEMICAL PRETREATMENT

Physical-chemical pretreatment methods are particularly useful in treating leachate from older/closed landfills that have lower biodegradable organic carbon, or as a polishing step for biologically treated leachate.

A brief description of some of the physical-chemical treatment processes applied to leachate pre-treatment is provided below.

#### 8.2.1 AIR STRIPPING OF METHANE

Air stripping to remove dissolved methane is normally a requirement, where leachate is discharged to sewer without any other pre-treatment. Raw leachate is often saturated with methane, containing up to 50 mg/l. Concentrations of methane as low as 0.5 mg/l in leachate can give rise to explosive concentrations of methane gas (5 to 15% by volume) in atmospheres. Removal of dissolved methane may be necessary to avoid the possibility of forming an explosive atmosphere in the sewer system.

#### Design Criteria

There has been little research into this area. One study at the University of Lancaster produced approximately 90% removal at 40 minutes retention time with vigorous aeration (36 m<sup>3</sup>/m<sup>3</sup>.hr) which fell to 75% removal at 6.7 minutes retention time. A full-scale plant on Merseyside, UK, has proved more efficient. A reactor with 1m leachate depth, divided

into 5 zones with baffles, has been operated at a 40 minute detention time and produces 99% methane removal at aeration rates of approximately 10 m<sup>3</sup>/m<sup>3</sup>.hr. In addition, a full scale plant at Hempsted Landfill, Gloucester, UK removes methane from up to 700m<sup>3</sup>/d using vigorous aeration and mixing.

#### 8.2.2 AIR STRIPPING OF AMMONIA

The higher the ammonia concentration and the lower the BOD:N ratio the more appropriate physico-chemical methods are likely to be. The BOD:N ratio generally considered optimum for sewage treatment is 100:5, whereas methanogenic leachates may have a BOD:N ratio of 100:100. Of the various physico-chemical processes, ammonia stripping offers the best potential as a process for nitrogen removal from leachates.

This is a mass transfer process using air to remove volatile gaseous ammonia in the leachate. Ammonia is highly soluble and in order to remove ammonia from a liquid it must be converted to gaseous free ammonia molecule, NH<sub>3</sub>, before stripping can take place. The pH-value of the leachate is adjusted to values of over 10 prior to being exposed to large quantities of air.

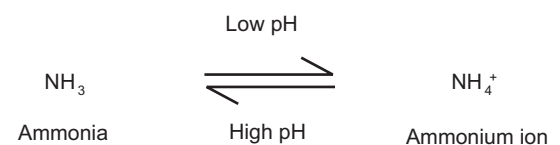

The alkali requirement to reach a pH of above 10 varies considerably from as low as 0.5 kg lime/m<sup>3</sup> for some methanogenic leachates to as much as 6 kg/m<sup>3</sup> for some acetogenic leachates. The process can be undertaken in a lagoon or in a purpose built stripping tower with relatively high air/leachate ratios. The greater the ratio the more efficient the process and the lower the relative cost. The concentration of ammonia released in a stripping tower exhaust would typically be a couple of hundred milligrams per cubic metre, which is below the level of toxic effect of 1700 mg/m<sup>3</sup>, but above the odour threshold of 35 mg/m<sup>3</sup> and so there would be detectable odour near the plant. Consequently, gas scrubbing or thermal destruction of gases would be required. Ammonia released from a tower stream can be controlled easier than the non-point releases from a lagoon.

During the ammonia stripping process, attention must be paid to other contaminants in the leachate and unacceptable emissions of volatile organic species should be avoided. This process is non-selective and any volatile species present in the leachate would be released. It should be noted that the resulting effluent may be neutralised with acid prior to discharge.

### Design Criteria

Although there is some dispute about the mechanism of ammonia removal, there is a general consensus that large volumes of air are needed, for example, gas-to-liquid ratios of up to 6000 for 90% ammonia removal (Fletcher and Ashbee, 1994). The head of liquid against which the air must be supplied, together with a large flow rate mean that a

substantial power input is needed. Stripping of ammonia is accomplished using packed towers, diffused aeration tanks or lagoons.

### 8.2.3 PRECIPITANTS/FLOCCULANTS

The addition of chemicals followed by a sequence of mixing, flocculation, coagulation and settlement may be used in conjunction with other treatment processes. The objectives of precipitation include:

- reduction in suspended solids in order to minimise problems of clogging;
- precipitation of calcium carbonate, iron, manganese and heavy metals to protect physical plant, prevent toxicity and inorganic solids build-

TABLE 8.1: LEACHATE TREATMENT METHODS AND OBJECTIVES

| Treatment Objective   | Main Treatment Options   | Type of Landfill <sup>1</sup> |
|---|--|-------------------------------|
| Removal of degradable organics (BOD)                            | Aerobic Biological <ul style="list-style-type: none"> <li>• Aerated lagoon / extended aeration</li> <li>• Activated Sludge</li> <li>• Sequencing Batch reactor (SBR)</li> </ul>  | II                            |
|   | Anaerobic Biological <ul style="list-style-type: none"> <li>• Upflow Anaerobic Sludge Bed (UASB)</li> </ul>  | II                            |
| Removal of ammonia  | Aerobic Biological <ul style="list-style-type: none"> <li>• Aerated lagoon / extended aeration</li> <li>• Activated Sludge</li> <li>• Sequencing Batch reactor (SBR)</li> <li>• Rotating Biological contactor</li> </ul> | II                            |
|   | Physico-Chemical <ul style="list-style-type: none"> <li>• Air Stripping of ammonia</li> </ul>  | II                            |
| Denitrification   | Anoxic biological<br>SBR   | II<br>II                      |
| Removal of non-degradable organics and colour                   | Lime/coagulant addition  | I,II,III                      |
|   | Activated Carbon   | I,II,III                      |
|   | Reverse Osmosis  | I,II,III                      |
|   | Chemical Oxidation   | I,II,III                      |
| Removal of hazardous trace organics                             | Activated Carbon   | I,II,III                      |
|   | Reverse Osmosis  | I,II,III                      |
|   | Chemical Oxidation   | I,II,III                      |
| Removal of methane  | Air stripping  | II                            |
|   | Aerobic biological (limited)   | I,II,III                      |
| Removal of dissolved iron and heavy metals and suspended solids | Lime/coagulant addition, aeration and settling   | I,II,III                      |
| Final polishing   | Reed Beds  | II                            |
|   | Sand filtration  | II                            |
| Volume reduction  | Reverse Osmosis  | I,II,III                      |
|   | Evaporation  | I,II,III                      |

Note 1: I= Non-hazardous industrial waste, II = MSW and co-disposal, III = Hazardous waste  
Modified from Hjelmar et al., (1995)



up in biological processes;

- removal of turbidity and colour from effluents;
- partial removal of organic loading; and
- removal of powdered activated carbon (during tertiary treatment).

Many chemicals have been used, e.g. hydrated lime, aluminum sulphate, ferric sulphate and polymeric coagulant aids. Hydrated lime has been found to be the most useful and cost effective precipitant.

### 8.3 BIOLOGICAL TREATMENT OF LEACHATE

At many sites leachate contains high concentrations of degradable carbon compounds or ammonia or both. It is for these components that biological techniques offer the most reliable and economic treatment. They may incidentally effect removal of iron, manganese and other metals, but they are not designed for that purpose.

Biological treatment methods are classified as aerobic and anaerobic according to microbial metabolism. In aerobic processes, micro-organisms generate energy by enzyme mediated electron transport using molecular oxygen as electron acceptor. In anaerobic processes, inorganic compounds such as nitrate, sulphate and carbon dioxide are used as electron acceptor.

Many biological processes are also able to treat, or tolerate hazardous components such as cyanides, phenols and pesticides. Certain organic compounds may be degraded more easily either by aerobic or anaerobic micro-organisms. For example, aromatic pollutants with several chloro, nitro and azo substituents are readily reduced by anaerobic micro-organisms while the reduced end products may be easily mineralised by aerobic bacteria. Thus, a combination of anaerobic and aerobic treatment may enhance mineralisation of complex compounds.

#### 8.3.1 ACTIVATED SLUDGE

##### Description

The activated sludge process is a suspended growth biological treatment system that uses aerobic microorganisms to treat ammoniacal nitrogenous substances and organic contaminants. Influent is introduced into a reactor where a mixed culture of bacteria is maintained in suspension. In the presence of oxygen, nutrients, organic compounds and acclimated biomass, a series of biochemical

reactions is carried out in the reactor that degrades the organics and generates new biomass. Figure 8.1 provides a schematic representation of a completely mixed activated sludge process.

FIGURE 8.1: ACTIVATED SLUDGE PROCESS

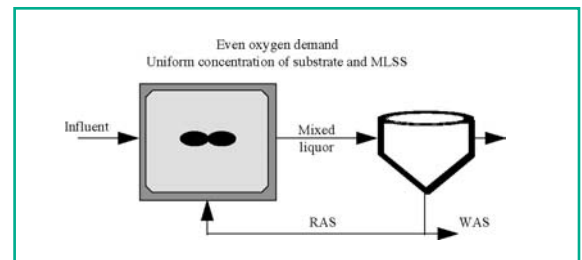

Diffused or surface aeration is used to maintain aerobic conditions in the reactor. After a specified period, the mixture of new cells and old cells is passed into a settling tank. A portion of the settled biomass is recycled to maintain the desired concentration of organisms in the reactor, and the remainder is wasted and sent to sludge handling facilities.

Nutrients (N or P) are common chemical requirements if they are not present in the leachate. For an aerobic process such as activated sludge treatment there will be residuals generated in the order of 0.1 to 0.6 g sludge per g COD removed at about 1.0% solids concentration.

Limitations to the activated sludge system include limited BOD loading capacity and flow balancing may be required to maintain stable flow and loading conditions. A conventional activated sludge system operated without additional process elements is unlikely to achieve the percentage ammoniacal nitrogen removal required in landfill leachate treatment.

TABLE 8.2: DESIGN CRITERIA FOR ACTIVATED SLUDGE PLANTS

| Parameter                | Range       |
|--------------------------|-------------|
| MLSS (mg/l)              | 3,000-6,000 |
| MLVSS (mg/l)             | 2,500-4,000 |
| F/M (kg BOD/ kg MLVSS/d) | 0.1-1.0     |
| SRT (days)               | 0.5-3       |
| RT (hours)               | 0.1-20      |



### 8.3.2 SEQUENCING BATCH REACTORS

The sequencing batch reactor (SBR) process is a form of activated sludge treatment in which aeration, settling, and decanting can occur in a single reactor. The process employs a five-stage cycle: fill, react, settle, empty and rest.

Waste water enters the reactor during the fill stage; it is aerobically treated in the react stage; the biomass settles in the settle stage; the supernatant is decanted during the empty stage; sludge is withdrawn from the reactor during the rest stage; and the cycle commences again with a new fill stage.

Figure 8.2 provides a schematic representation of the SBR process.

The advantages of SBR systems include:

- simple and reliable;
- ideally suited for wide flow and influent quality variations;

FIGURE 8.2: SEQUENCING BATCH REACTOR

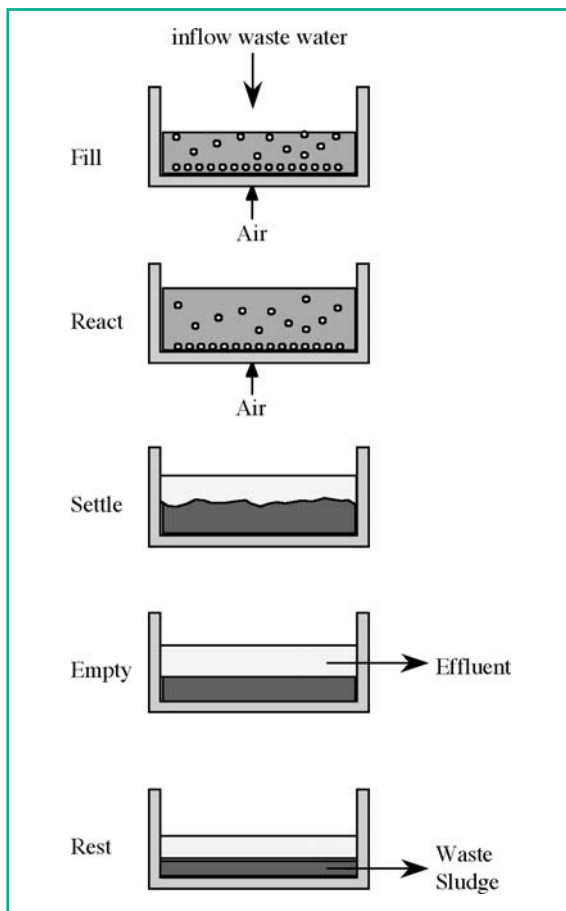

- high quality effluent achievable;
- requires less operator attention than most other mechanical systems; and
- operational flexibility which can be used for nitrification, denitrification and phosphorus removal.

Critical components of an SBR system include the aeration/mixing process, the decant process, and process controls.

SBR systems are capable of producing a high-quality effluent. They can be modified to remove nitrogen and phosphorus.

The SBR system requires less operator attention than most alternatives. SBR technology is well established in many European countries.

The disadvantages of SBR systems include:

- complex control system;
- a skilled operator may be required; and
- problems have been reported with emptying process in poorly designed systems.

TABLE 8.3: DESIGN CRITERIA FOR SEQUENCING BATCH REACTOR

| Parameter   | Range        |
|---|--------------|
| MLSS (mg/l)   | 3,000-10,000 |
| F/M (kg BOD/ kg MLVSS/d)                            | 0.05-0.54    |
| Max. volumetric COD load (kg COD/m <sup>3</sup> /d) | 0.48-2.16    |
| SRT (days)  | 10-30        |
| RT (days)   | 4-50         |

### 8.3.3 AERATION LAGOONS

Extended aeration treatment is usually carried out in lagoons. Advantages of this treatment method include:

- is a flexible form of leachate treatment; and
- it can readily cope with a wide range of flows and strengths of leachate.

Disadvantages of aeration lagoons include:

- large heat losses due to surface area and mechanical aerators - nitrification is temperature sensitive;
- the large land area requirement which may not be problematic on a landfill - however, ground conditions are important;
- poor settling if very low BOD/NH<sub>3</sub> ratio;
- odour and aerosol formation;
- not amenable to covering to conserve heat; and
- low energy efficiency of mechanical aerators and may lose nitrification in winter.

### Design Criteria

UK experience indicates BOD removal (c. 90%) can be obtained at loading rates of c.0.5 kg BOD/m<sup>3</sup>.day. In order to achieve complete BOD removal (<25mg/l) loadings of 0.025 to 0.05 kg BOD/m<sup>3</sup>.day can be tolerated. Removal efficiencies at these loading rates are approximately three-fold lower than that obtained using an activated sludge system.

### 8.3.4 ROTATING BIOLOGICAL CONTACTORS

The Rotating Biological Contactors (RBC) is an aerobic fixed-film biological treatment process. The RBC consists of a series of closely spaced plastic (polyethylene, polyvinyl chloride or polystyrene) disks on a horizontal shaft. Figure 8.3 provides a schematic representation of the RBC process.

FIGURE 8.3: ROTATING BIOLOGICAL CONTACTOR

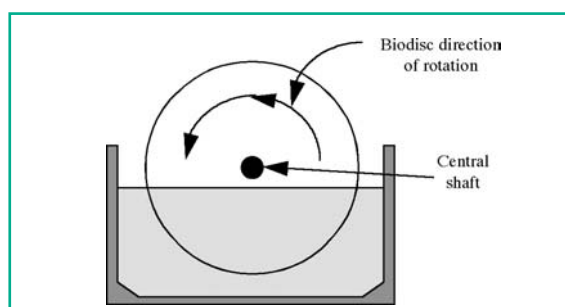

In the usual RBC design, the disc (that can measure up to 4 m in diameter and 7 m in length) is rotated at 1-10 revolutions per minute; the assemblage is placed in a tank, and the media are immersed to a depth of about 40% of their diameter. The rotation of the assemblage ensures that the media are alternately in air and waste water resulting in the development of a biofilm. Oxygen moves into the

biofilm when it is in the air. Oxygen may move into or out of the biofilm when it is in the waste water; this depends in part, on the relative concentrations of oxygen in the waste water and biofilm. Carbonaceous oxidation will occur at the inlet end, and if there is sufficient media, nitrification will then occur further along the shaft.

A cover is needed to protect the biofilm from heavy rain, frost and snow, and for safety. There are a number of variations of the RBC system which differ, mainly, in the way that the media is assembled on the support structure. In general, they are more commonly used for weak leachates.

The advantages of an RBC system include:

- low maintenance;
- ability to function under conditions of shock loading;
- low running costs;
- low noise levels;
- no fly nuisance;
- low operator skill requirement;
- low head loss through the system;
- plant can be covered and insulated;
- inconspicuous if colour keyed;
- good solids settlement;
- low sludge production; and
- possibility of nitrification and denitrification.

The disadvantages of an RBC system include:

- package plants may have an insufficient sludge storage volume which could lead to overloading of the biofilm;
- power failure, interrupting disc rotation, can cause uneven growth of biomass which overloads bearings and shafts causing unit failure;
- high organic loads can give difficulties;
- control systems must be able to sense overloads; and

- structural damage can be expensive.

TABLE 8.4: DESIGN CRITERIA FOR RBC

| Parameter  | Range       |
|--|-------------|
| MLSS (mg/l)  | 3,000-4,000 |
| MLVSS (mg/l)   | 1,500-3,000 |
| F/M (kg BOD/ kg MLVSS/d)   | 0.05-0.3    |
| Normal BOD loading rate (g BOD/m <sup>2</sup> /d)                          | 3-10        |
| Normal NH <sub>3</sub> loading rate (g NH <sub>3</sub> /m <sup>2</sup> /d) | 1-4         |
| Maximum BOD loading rate (g BOD/m <sup>3</sup> /d)                         | 0.24-0.96   |
| HRT (days)   | 1.5-10      |

### 8.3.5 COMBINED LEACHATE AND URBAN WASTEWATER TREATMENT

Dedicated systems for the treatment of leachate on-site may not be required in all cases. Spare treatment capacity may be available at an existing municipal wastewater treatment plant (WWTP) in the vicinity of the landfill. In these cases, combined leachate treatment in the WWTP may be possible. The requirements are:

- capacity to treat the leachate;
- process compatibility with the leachate characteristics; and
- ability to treat the sludge.

It should be noted that leachate may be 30-50 times stronger than urban wastewater and spare capacity at a WWTP could be quickly used up. Although BOD<sub>5</sub>, COD and heavy metal reduction is well established, the effects on heavy metals, ammonia conversion, sludge production, foaming, solids settleability, and precipitate formation are less well established.

It is accepted that leachate quality has some impact upon the performance of the treatment plant. In general, up to 4% leachate by volume can be tolerated without any significant effect on the treatment process or the effluent quality. However, the performance must be investigated on a case by case basis. When toxins are expected or where a high proportion of leachate is to be treated, pretreatment may be required. A simple aerated lagoon may provide the pretreatment required.

### 8.3.6 ANAEROBIC TREATMENT

In general, biological treatment of leachates has been by aerobic methods. However, anaerobic treatment methods have also been used for the biological treatment of leachates. The process offers several benefits over aerobic processes. Among these are:

- lower sludge production;
- lower energy demand (i.e. no oxygen requirement); and
- recovery of methane may provide energy.

There are relatively few full-scale anaerobic leachate treatment plants worldwide although much pilot-scale digester evaluation has been undertaken. Two major problems make this form of treatment generally unsuitable for leachate treatment. When methanogenic conditions exist in the landfill mass anaerobic plants are largely redundant. Further, the inability of anaerobic processes to remove ammonia has also discouraged their wider use.

### 8.3.7 BIOLOGICAL NITROGEN REMOVAL

Nitrogen in leachate can be present both in organic (e.g. amino acids) and inorganic (e.g. ammonia) forms. Nitrogen can be removed biologically by assimilation and nitrification-denitrification.

Nitrification-denitrification involves two process steps. In nitrification, ammonia is converted to nitrate in a series of reactions under aerobic conditions. Denitrification on the other hand, involves the stepwise reduction of nitrate to nitrogen gas under anoxic conditions.

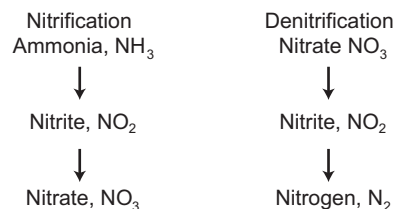

Thus for leachate treatment, low removal of nitrogen is expected in anaerobic processes since the majority of nitrogen is in ammonia form, whereas aerobic processes designed for nitrification should be feasible for nitrogen (ammonia) removal. For example, the normal NH<sub>3</sub> loading rate to an RBC is 4g NH<sub>3</sub>/m<sup>2</sup>/d. Nitrifying bacteria have long doubling times and in order to promote a more efficient treatment regime it is desirable to operate nitrification at 20°C. Many of the dedicated

nitrification treatment systems in Europe are designed to operate at greater than 20°C utilising landfill gas to heat the leachate because at lower temperatures there is little nitrifier growth. Denitrification requires a carbon source in order to convert nitrate to nitrogen gas (C/N ratio c. 3:1) and where this is deficient an external sources such as the addition of methanol is required.

#### 8.4 PHYSICAL-CHEMICAL / BIOLOGICAL TREATMENT OF LEACHATE

Compact systems for the treatment of concentrated wastewaters are becoming increasingly more important. Combinations of biological treatment and membrane technology are used in the treatment of leachate.

##### 8.4.1 MEMBRANE BIOREACTOR

In the membrane bioreactor configuration the wastewater to be treated flows into an aeration chamber, where the biodegradable organic matter and the reduced nitrogen compounds are oxidised. The sludge flow is channelled through an ultrafiltration unit where the mixed liquor and water are separated from each other. The filtrate is drained off as effluent and the concentrate is recirculated to the aeration chamber. Surplus sludge is discharged via a sludge valve.

This compact system differs from conventional systems in the following ways:

- it can be operated with a high biomass concentration with sludge concentrations up to 20 to 30 g/l feasible. As high biomass concentrations are maintained this allows for a high volumetric loading rate;
- the high sludge age and high temperature lead to extensive mineralisation, resulting in little net sludge production;
- the specific activity of the biomass is maximised as the process is exothermic and can take place at temperatures ranging from 35°C to 38°C;
- oxygen transfer into the aeration tank is considerably more efficient because the system operates under pressure which ensures a sufficient oxygen supply despite the high volumetric loading rate and correspondingly high oxygen demand;

- the entirely closed system is maintained under pressure by direct air injection. The off-gases are released via a pressure relief valve. Thus, air emissions are manageable and can be treated if necessary;
- the air emissions are considerably less than in conventional systems, because the volume of air is 4-5 times lower due to more efficient oxygen transfer; and
- the use of ultrafiltration membranes for sludge separation improves the effluent quality. The effluent is free of suspended solids and has low COD, N and micropollutant levels.

There are 13 full-scale plants in Germany with one such system treating leachate (275m<sup>3</sup>/day) containing high COD and ammonia concentrations. In addition, pilot studies have demonstrated COD and ammonia removal efficiencies of 90 and 99.9%, respectively at a ammonia loading rate of 1.7 kg N/m<sup>3</sup>/d. It should be noted that German leachates are generally lower in organic content (BOD, COD) than Irish leachates as there is less biodegradable waste landfilled.

FIGURE 8.4: MEMBRANE BIOREACTOR SYSTEM

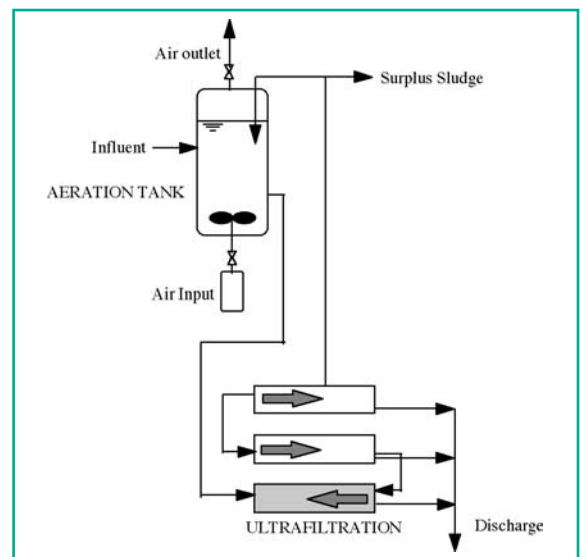

#### 8.4.2 POWDERED ACTIVATED CARBON (BIOLOGICAL)

This system involves the controlled addition of powdered activated carbon to an activated sludge system, achieving a higher degree of treatment than possible by either method alone. The presence of carbon in the aeration basin removes:

- some refractory organics;
- enhances solids settling; and
- buffers the system against load fluctuation and toxic shocks.

The practice of adding powdered carbon in leachate treatment started in the 1980's.

**TABLE 8.5: DESIGN CRITERIA FOR POWDERED ACTIVATED CARBON SYSTEM**

| Parameter                                | Range        |
|--|--------------|
| Carbon Dosage (mg/l)                     | 50-10,000    |
| MLSS (mg/l)                              | 2,000-11,000 |
| F/M (kg BOD/ kg MLVSS/d)                 | 0.05-0.3     |
| Max. COD load (kg COD/m <sup>3</sup> /d) | 3.2          |
| RT (days)                                | 1-16         |

#### 8.4.3 FILTRATION

The filtration process consists of a fixed or moving bed of media that traps and removes suspended solids from leachate passing through the media. Monomedia filters usually contain sand, while multimedia filters include sand, anthracite and possibly activated carbon.

In the filtration process leachate flows downward through the filter media. Particles are removed primarily by straining, adsorption, and microbiological action.

Desirable characteristics for all filter media are as follows:

- good hydraulic characteristics (permeable);
- backwash facility requirement;
- does not react with substances in the water (inert and easy to clean);
- hard and durable;

- free of impurities; and
- insoluble in water.

Gravel is used to support the filter sand and should have similar characteristics.

This type of treatment system could also be termed a tertiary or an advanced treatment system in the context of leachate treatment after primary treatment in an SBR/aeration lagoon. This system is generally effective on leachates with low organic content but can be prone to clogging.

Further details on the operation and maintenance of sand filters were outlined previously in the Agency's *Water Treatment Manual: Filtration* (EPA, 1995).

#### 8.4.4 OTHER TREATMENT SYSTEMS

There are many other treatment systems being tested at present at lab, pilot and full-scale. The use of peat for the treatment of leachate is being tested at present at an active landfill in Laois and at a closed landfill in Kerry. The preliminary results are encouraging although no design details are to hand at present.

### 8.5 ADVANCED TREATMENT METHODS

The following methods are more commonly used for tertiary treatment of leachate in particular prior to discharge to surface waters.

#### 8.5.1 ACTIVATED CARBON ADSORPTION

This method involves constructing a vessel filled with particles of carbon which are porous and have a high surface area. Activated carbon is made from coal, wood, coke or coconuts and has 500-1300m<sup>2</sup> of surface area per gram. When leachate is passed through, contaminants within the leachate are adsorbed or attached to the carbon. The system has to include either provision for the carbon to be regularly back-flushed or replaced. Figure 8.5 is a schematic representation of a typical activated carbon treatment system. Leachate high in suspended solids (>50mg/l) should be filtered before activated carbon treatment. Back-flushing is necessary because the surface of the carbon becomes covered with the contaminants and it also prevents clogging. The disposal of the carbon and the flushing effluent will also have to be addressed as they will have significant cost implications.

The process is particularly well suited for:

- the removal of hazardous organics from industrial leachate;
- the removal of traces of AOX from domestic waste leachates; and
- removal of colour and residual refractory TOC and COD from stabilised leachates.

This process is typically used for removing non-volatile organics following air stripping. Adsorption capacities of 0.5 to 10 percent by weight are typical and the carbon can be regenerated for reuse. Under optimum conditions, carbon adsorption can achieve 99% removal of most organic contaminants but the capital outlay for their installation is very high and running costs can be high.

#### Design Considerations and Criteria

Design and operational considerations include:

- provide sample valves in the piping to monitor for breakthrough;
- pressure drop: 0.69 to 6.9 Kilopascal per canister (water);
- empty bed contact time (EBCT): 15 to 60 minutes typical for liquid systems which is determined in a pilot trial or from carbon supplier;
- volume of carbon: calculated from EBCT multiplied by flow rate;
- hydraulic loading rate: 84-336 l/min/m<sup>2</sup>;
- impurity loading rate: amount of contaminant adsorbed per gram of gram;
- humidity: decreases vapor-phase carbon effectiveness;
- temperature: decreases vapour-phase carbon effectiveness, but will offset negative effect of humidity if air is pre-heated, for a net gain of carbon effectiveness;
- flow direction: downflow mode is most common for liquid flow. Upflow variation used for high suspended solids waters;

- backwash: permanent carbon installations are normally equipped with a backwash system to purge entrapped suspended solids from the carbon bed. Air scour may be included to detach biological growth from the carbon;
- safety: consider dust when handling bulk carbon. Spontaneous combustion is possible; and
- construction materials: use carbon steel vessels with epoxy coating.

#### 8.5.2 REVERSE OSMOSIS

If a semi-permeable membrane is placed between two solutions of differing concentration, pure water will travel through the membrane until equilibrium of concentration is achieved. This process is called osmosis. If the pressure in the more concentrated solution is increased, the flow will be reversed (see Figure 8.6). This process known as reverse osmosis can be used to reduce the volume of a leachate by producing a smaller amount of a more concentrated solution "brine" which can comprise 25 to 40% of the volume of the influent leachates. The most commonly used materials for membranes are cellulose acetate, aromatic polyamide and thin-film composites. It should be noted that the membrane used is very fragile, has a limited life of approximately 2 years and is susceptible to blockage and contamination and would only be suitable at the later stages of a treatment facility in combination with evaporation.

Applications of the system include:

- the removal of suspended and colloidal materials;
- the removal of colouring agents;
- the removal of ammoniacal nitrogen, heavy metals, most dissolved solids; and
- reduction in COD and BOD.

It may be suitable for application to leachates with a high inorganic loading and low volumetric flow rates. The capital costs of installing such a system would be very high as would the running costs. Provision would also need to be made for the treating or disposing of the highly concentrated liquors which would be produced.



**FIGURE 8.5: SCHEMATIC REPRESENTATION OF ACTIVATED CARBON TREATMENT SYSTEM**

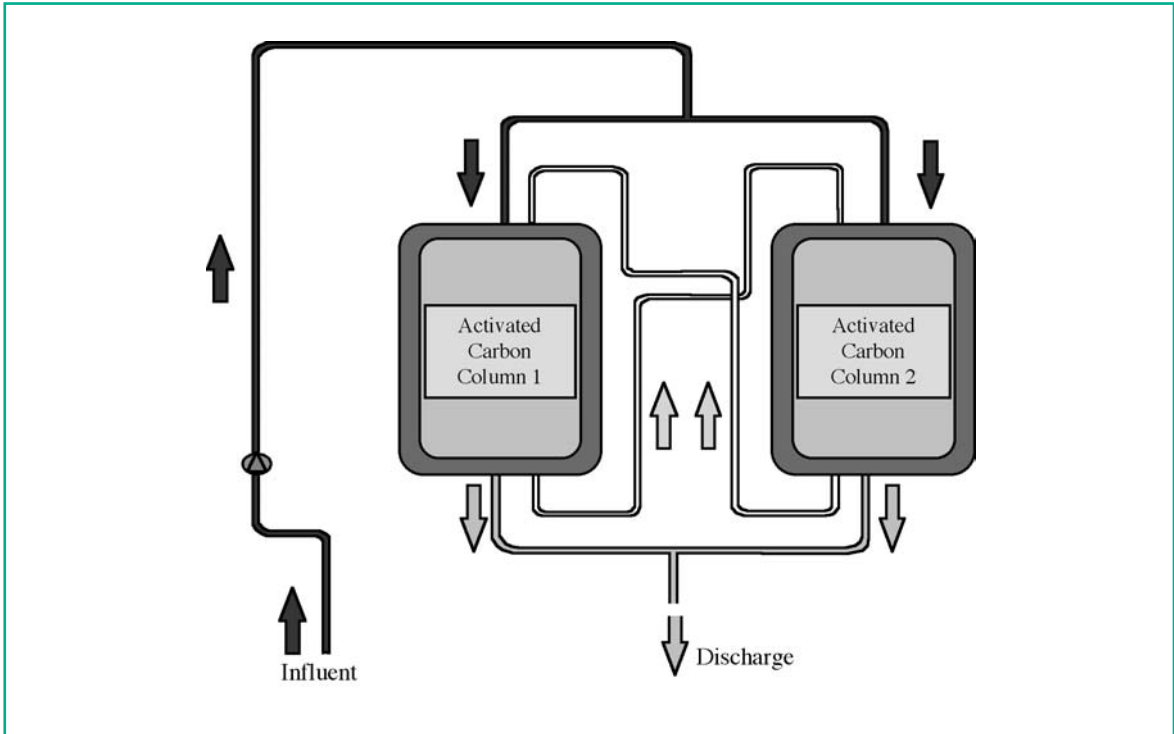

**FIGURE 8.6: REVERSE OSMOSIS TREATMENT SYSTEM**

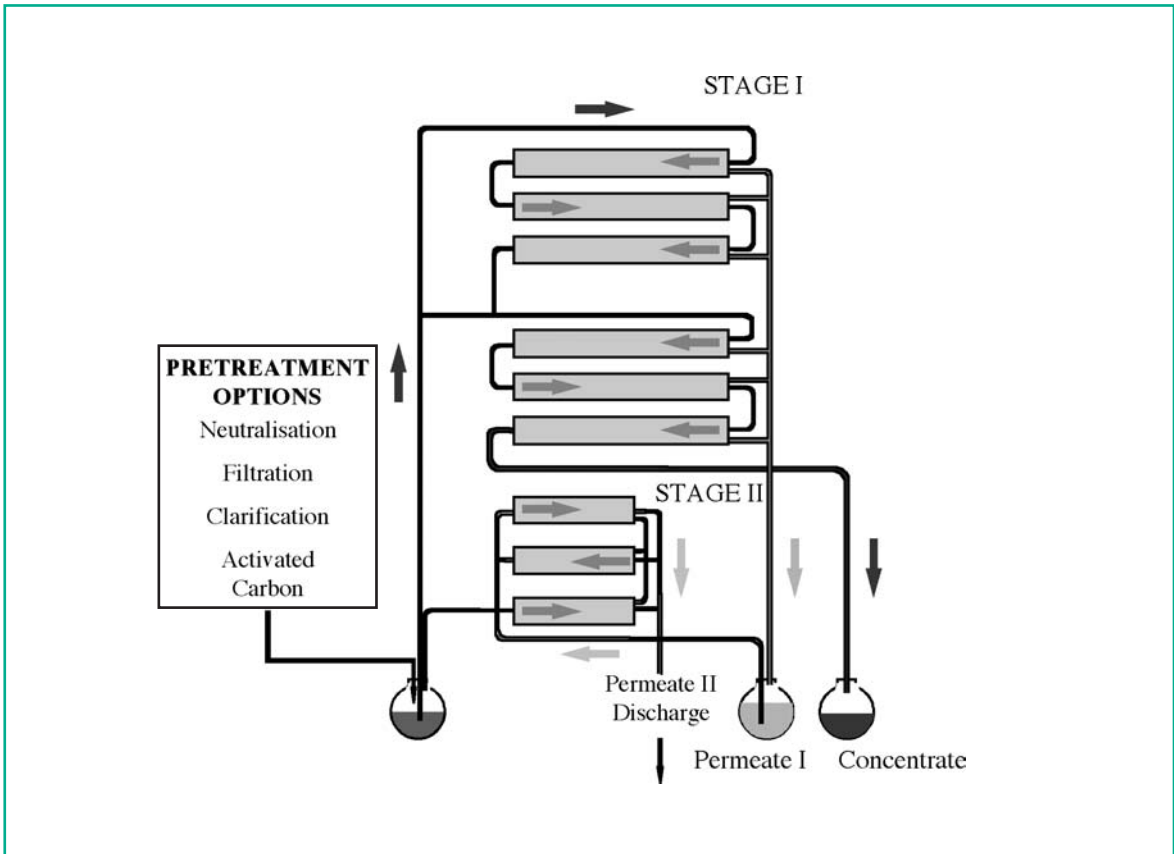



### Design Criteria

Typical reverse osmosis membrane pore sizes range from 5 to 20 Angstrom units while pressures of 2000 to 4000 kPa are usually encountered. Typical design parameters are:

- influent quality: less than 50g/l total dissolved solids. Minimum levels of magnesium, iron, sulphates, calcium carbonate, silicates, chlorine and biological organisms;
- suspended solids: remove colloids, silt with 5 to 10µm filters;
- pressure: 2000-4000kPa; and
- product water flow: 42-420 l/m<sup>2</sup>/day.

#### 8.5.3 CHEMICAL OXIDATION

Chemical oxidation is used for the destruction of cyanides, phenols and other organics and the precipitation of some metals. This treatment technology is well established for large-scale industrial applications. The redox reactions are those in which the oxidation state of at least one reactant is raised while that of another is lowered.

Chemical oxidation should be considered for:

- dilute aqueous streams containing hazardous substances; or
- for removing residual traces of contaminants after treatment.

Before chemical oxidation, leachate should be treated with complete nitrification in a biological purification stage.

The process for the chemical oxidation of leachate includes adjustment of the pH of the solution.

The oxidising agent, which may be in the form of:

- a gas (e.g. ozone);
- a liquid (e.g. hydrogen peroxide); or
- a solid (e.g. potassium permanganate).

#### 8.5.4 EVAPORATION

This is a two to four stage process which concentrates contaminants in leachate by evaporation and distillation. The process steps

include:

- the leachate is pre-treated by the addition of acid to reduce the pH value and to convert volatile ammonia into soluble ammonium salts;
- the leachate is evaporated and separated into distillate and residual liquor. The leachate is evaporated using a relatively low heat source and separated into distillate and concentrate;
- the distillate may require further treatment prior to discharge as it would contain any volatile substances left in the leachate after pre-treatment; and
- the concentrate could be distilled further into distillate and sludge, the sludge requiring either thermal treatment or disposal to landfill.

The process has not been widely adopted as it is expensive and like reverse osmosis is a pre-concentration technique producing a condensate or sludge residue (c.5% of the original volume) which must be disposed of. Consequently, there is little design information available on this treatment method.

#### 8.5.5 REED BED TREATMENT

This treatment method relies on the ability of the reeds to transfer oxygen to their extensive rhizomatous root system, stimulating the growth of bacteria in the surrounding soil medium, which break down organic substances in this root zone. Other constituents of the effluent may be immobilised or adsorbed by the plants themselves. Reed bed systems have found applications for the treatment of industrial effluents and landfill leachates.

Figure 8.7 is a schematic representation of a reed bed system. General principles have been established for reed bed design including:

- a typical design loading of 11 g of BOD per m<sup>2</sup> of bed (in waste water terminology a loading rate of 5 m<sup>2</sup> of bed area per population equivalent) (Robinson *et al.*, 1991);
- a flat surface to the bed to allow flooding to be used as a means of weed control;
- an adjustable discharge outlet to assist in the flooding of the bed;

- fill media with a hydraulic conductivity of at least  $1 \times 10^{-3}$  m/s. The media should be washed before placement. Gravel beds of high permeability enable very flat gradients to be designed and flooding can readily be accomplished, to achieve weed control. Gravel beds also allow rapid and controlled changes in water level raising it to ground level to prevent drought, and lowering it to aerate the bed and encourage deep rhizome growth;
- a minimum depth of soil or gravel in the reed bed of 0.6m at the inlet end, this corresponds to the maximum depth to which *Phragmites australis* (the common reed) will grow. The outlet end being deeper (dependent on the hydraulic conductivity of the media) to allow for 0.5% - 3% slope on the base. This enables the reed bed to be drained if necessary; and
- provision of a lining system beneath the reed bed. The make up of the lining system should follow the general guidance given under *Leachate Storage* in Chapter 7.

A good removal of organic components (including residual BOD<sub>5</sub>, COD and suspended solids) and some denitrification takes place but poor removal of ammoniacal nitrogen is also a common finding with these systems. This is likely to limit the value of reed beds for treating raw leachates. However, reed bed treatment systems have considerable potential for treatment at older sites with dilute leachates and tertiary treatment of leachates prior to discharge to surface waters.

The Agency's Wastewater Treatment Manual '*Treatment Systems for Small Communities, Business, Leisure Centres and Hotels*' provides further details on reed bed systems.

FIGURE 8.7: REED BED SYSTEM

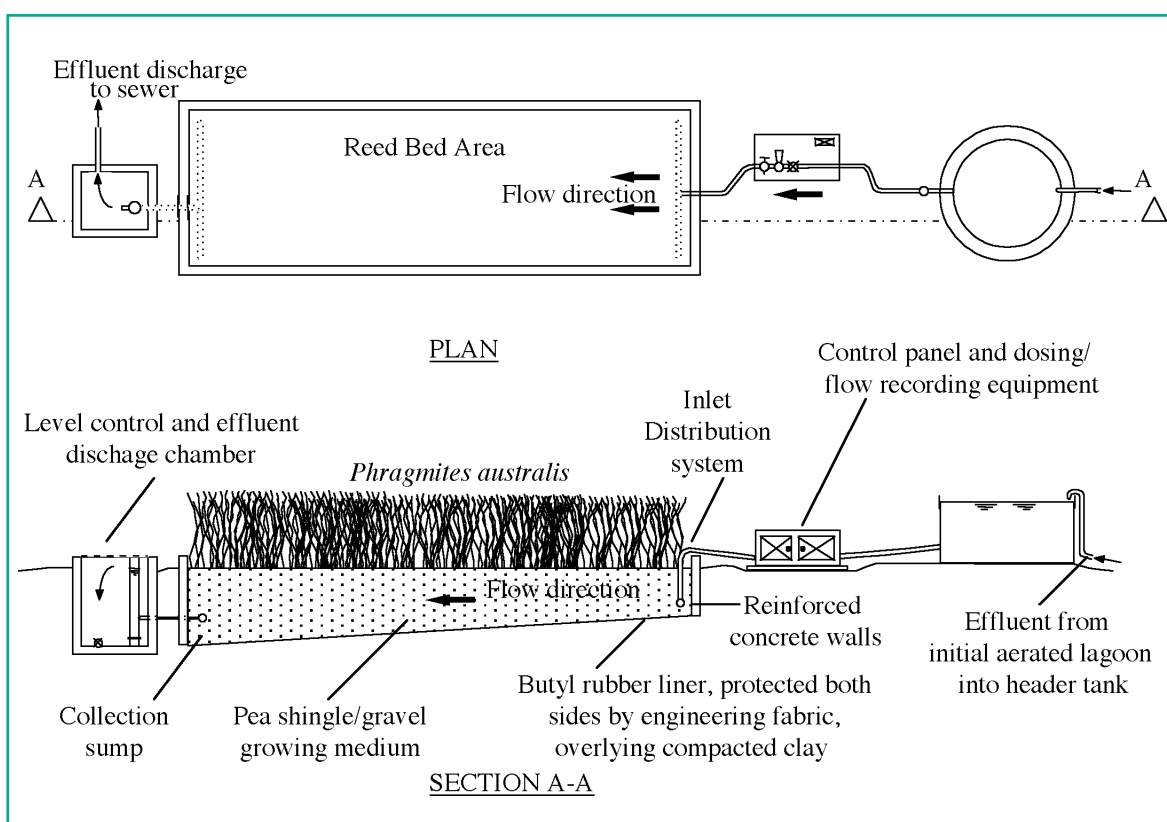

## 8.6 RESIDUALS MANAGEMENT

One of the most significant issues encountered in designing leachate treatment systems is the management and disposal of residues generated from the treatment processes. These include:

- suspended solids sludges resulting from wastewater sedimentation or filtration processes;
- concentrated brine solutions generated from reverse osmosis separation processes;
- metal sludges produced by chemical precipitation;
- spent carbon from activated carbon adsorbers;
- concentrated ion exchange regenerant solutions; and
- waste biological sludges.

Further details on residuals management from leachate treatment facilities are outlined elsewhere (Weber and Holz, 1991; US EPA, 1995).

## 8.7 LIFE CYCLE CONSIDERATIONS

Many factors need to be considered when designing a leachate treatment system. For example, leachate flows and characteristics are a function of the wastes landfilled and age, as well as the site's prevailing weather conditions and geology. Flows may increase during winter months. Organic acid production usually increases in the early years, then decreases as the landfill contents age. The leachate will require treatment during the active years of the landfill and for many additional years, possibly decades, after the facility is closed.

To successfully engineer a leachate treatment system, the designer should take into account these considerations, and develop a "life-cycle design".

As the life cycle of the project develops, physical or chemical changes may occur that require adjustment of the original design. The designer should incorporate flexibility into the design. For short-term projects, it is advisable to consider use of package plants; equipment that may be easily converted from one configuration to another. On the other hand, long-term projects may justify the installation of permanent treatment structures.

The traditional method used to compare treatment

alternatives consists of amortising capital costs into an annual cost and adding it to other operating costs (e.g. chemicals, power, disposal and maintenance costs). The option that meets the treatment objective(s) (see Tables 8.1) and has the lowest estimated annual operating cost is usually selected. However, the conditions and changes that occur during the life of the project must be taken into consideration. For example, the efficiency of some processes, such as biological treatment, may decrease as concentrations begin to decrease.

A variety of physical - chemical and biological treatment techniques are available each of which vary in cost, applicability and effectiveness. More detail on the comparative performance of these methods is presented in Appendix D2. The level of control needed for successful operation of one such leachate treatment plant is detailed in Appendix D3. It is essential that leachate treatment plants are designed using process expertise, such as would be applied to the design of a treatment system for an effluent from an industrial process.

Figure 8.8 provides a schematic of the leachate treatment design process.

FIGURE 8.8: LEACHATE TREATMENT - SCHEMATIC OF THE DESIGN PROCESS

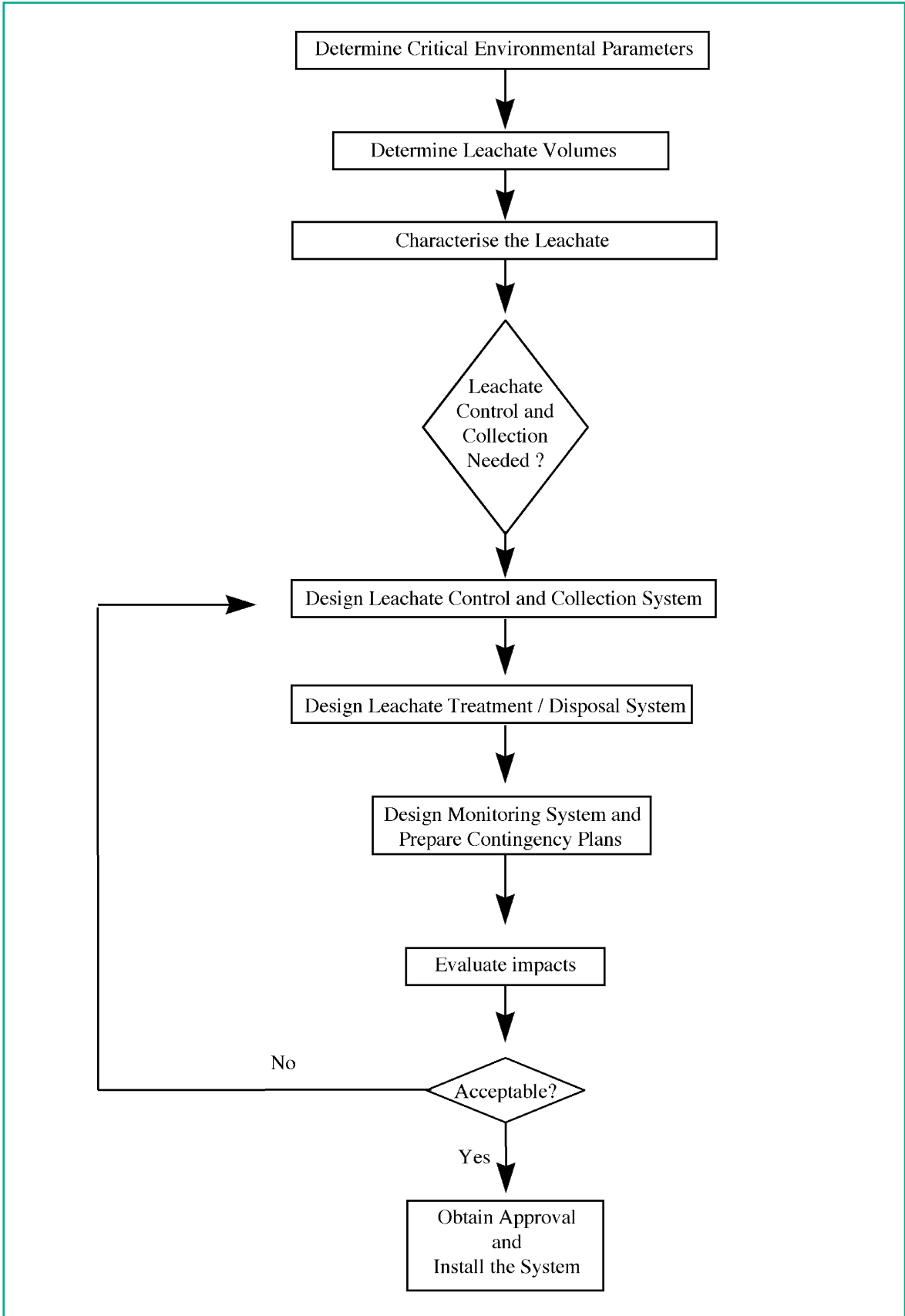

## 9. LANDFILL GAS MANAGEMENT

### 9.1 INTRODUCTION

Landfill gas (LFG) results from the biodegradation of wastes. Gas production within the landfill takes place at elevated temperatures and the gas will invariably be saturated with water vapour. Undiluted landfill gas can be expected to have a calorific value of 15 to 21 MJ/m<sup>3</sup> (half that of natural gas).

The major components of landfill gas are methane and carbon dioxide (typically in a 3:2 ratio) with a number of minor constituents in low concentrations. Methane is flammable and can be an asphyxiant. Carbon dioxide is an asphyxiant. The occupational exposure limits for carbon dioxide are short term (15 minutes) 1.5% and long term (8 hours) 0.5% by volume in air. Typical landfill gas composition is given in Appendix E, Table E.1.

Fires and explosions can occur when a flammable gas or vapour from a flammable liquid mix with air and ignite when within certain concentration limits. The concentration limits are known as the Lower Explosive Limit (LEL) and the Upper Explosive Limit (UEL). The LEL and UEL of methane are approximately 5 and 15% v/v respectively.

The accumulation of a mixture of methane and air in a confined space between the LEL and UEL concentrations range will explode if ignited. Figure 9.1 illustrates the limits of flammability of mixtures of methane, air and nitrogen. For a typical landfill gas mixture the minimum air requirement to sustain combustion is approximately 79% (approximate oxygen content 16.6%).

### 9.2 OBJECTIVES OF A LANDFILL GAS MANAGEMENT SYSTEM

The purpose of a landfill gas management system is to:

- minimise the impact on air quality and the effect of greenhouse gases on the global climate;
- minimise the risk of migration of LFG beyond the perimeter of the site;
- minimise the risk of migration of LFG into services and buildings on site;
- avoid unnecessary ingress of air into the landfill

and thereby minimise the risk of landfill fires;

- minimise the damage to soils and vegetation within the restored landfill area;
- permit effective control of gas emissions; and
- where practicable permit energy recovery.

### 9.3 QUANTITY OF LANDFILL GAS GENERATED

The rate of gas generation at a landfill site varies throughout the life of a landfill and is dependent on factors such as waste types, depths, moisture content, degree of compaction, landfill pH, temperature and the length of time since the waste was deposited. Therefore predicting gas quantities is subject to significant uncertainty.

Models should be used to estimate the likely landfill gas production rates. This should be reinforced by detailed analysis and appropriate investigation techniques at a later stage of the development of the landfill.

There are a number of methods of assessing landfill gas quantity which include a rule of thumb method, a pumping method and computer modeling. As a rule of thumb it can be assumed that every tonne of degradable waste will produce about 6m<sup>3</sup> landfill gas per year for ten years from the time of emplacement.

FIGURE 9.1: LIMITS OF FLAMMABILITY OF MIXTURES OF METHANE, AIR AND NITROGEN

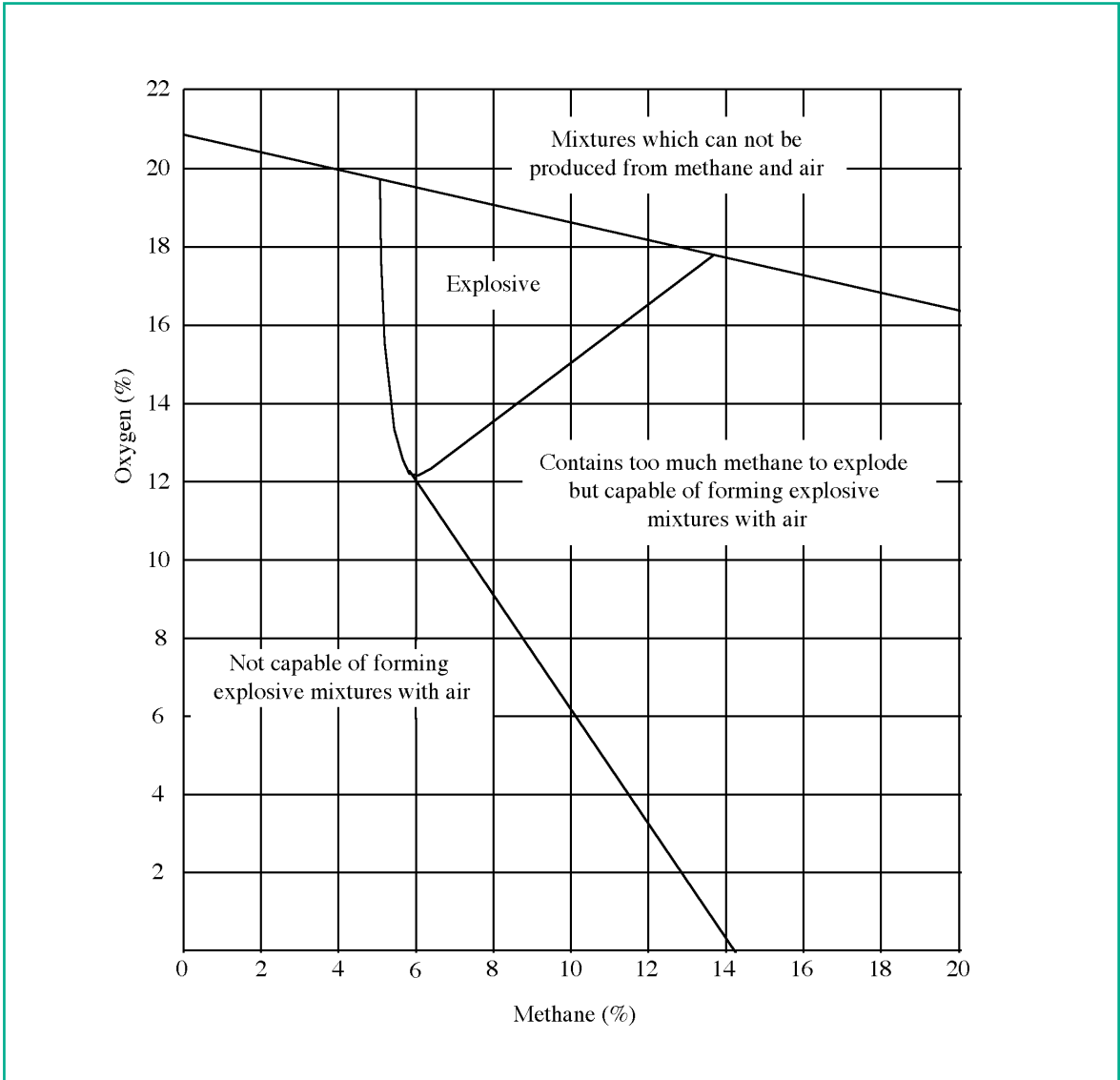

Under optimum conditions, one tonne of degradable waste can theoretically produce 400-500m<sup>3</sup> of landfill gas. In practical terms, the rate at which landfill gas may be collected for utilisation purposes will be much lower. Typically, a value of 200m<sup>3</sup> or less of landfill gas per wet tonne of municipal waste may be produced.

A survey of 262 sites (Gregory *et al.*, 1991) gave an average cumulative landfill gas yield of 146m<sup>3</sup>/t (wet, as delivered to the site) of which approximately 70% could be recoverable for utilisation. This gives an achievable LFG yield of 102m<sup>3</sup>/t, over the site lifetime.

### Pumping Trials

Gas pumping tests enable analysis of gas composition and estimates of production of LFG in addition to determination of well performance. Pumping trials have the advantage of being site specific. The gas generation rate obtained from pumping tests can be assessed for the whole site or for part of the site. Pumping tests in selected areas of a site are scaled up and are assumed to be representative of the whole site.

The pumping test involves pumping at a gas well and monitoring surrounding wells or piezometer probes arranged radially around the test well. Parameters measured at the well head during the test include gas flow rate, pressure, applied suction and gas quality. The zone of influence is determined from the data at the monitoring points. The pumping trial test should run until steady state conditions are met. At this stage the landfill gas quality should stabilise and the flow of the landfill gas at the well head should essentially be the gas generation rate. A critical factor in the use of pumping trial data is the accurate estimation of radii of influence of test wells.

### Models

An estimate of gas yield can be obtained from computer modelling either as an alternative to pumping trials or in conjunction with them. The reliability of the models prediction will depend upon the availability of site specific data. Input data that may be required for a model is given in Table 9.1.

The gas yield can be used to size the control plant and determine the economics of utilisation.

TABLE 9.1: MODEL INPUT DATA

#### Input Data

|                                |
|--------------------------------|
| date landfilling starts        |
| date landfilling ends          |
| mass of waste in place         |
| rate of infilling              |
| waste types                    |
| baled/shredded/compacted       |
| gas extraction and composition |
| moisture content               |
| packing density                |
| gas and waste temperature      |
| pH of waste in place           |
| fraction of waste components   |
| waste degradation rates        |
| fraction of degradable carbon  |
| gas recovery effectiveness     |

## 9.4 LANDFILL GAS CONTROL

Landfill gas may migrate by diffusion, convection or by water transport. These modes of transport of gases are independent of each other but may occur simultaneously so that migration control measures may mitigate one without removing the risk presented by the others.

Diffusion results in gas moving from an area of high concentration to an area of low concentration. Convection results in gas moving from areas of high pressure to areas of low pressure. Gas pressure depends on factors such as changes in atmospheric pressure, changes in water table and changes in bacterial activity. The distance the gas travels is influenced by the ease of the migration path and by the pressure of the gas in the landfill.

Landfill gas may also migrate from the facility in solution. The solubility of methane increases appreciably when pressure is increased. LFG can migrate from the site via the leachate or via groundwater. The gas is freed from solution as pressure changes or/and as evolved by continuing microbial action within the liquid.

The presence of dissolved methane in water/leachate can be assessed by methods outlined in '*The Measurement of Methane and Other Gases from the Ground*', CIRIA Report 131. Further information on dissolved gasses is given under the sections on leachate management and treatment (Chapters 7 & 8). The significance of dissolved gasses in leachate are given in Section 7.1.3. and an example of a treatment method to remove dissolved methane is provided in Section 8.2.1.



The main options for managing landfill gas at landfill facilities are:

- barriers;
- venting; and
- active control and flaring.

A combination of landfill gas control measures is likely to be required at a site.

Methane is estimated to be 20 - 30 times more damaging (per molecule) than carbon dioxide to the global climate due to its greenhouse effect. The combustion of landfill gas either in flares or as part of an energy recovery process converts methane to carbon dioxide and should be undertaken whenever the landfill gas yield is capable of supporting combustion. Active landfill gas systems should be designed to enable easy conversion to a passive system when gas production diminishes.

Landfill gas should, where practicable, be collected from all landfills receiving biodegradable waste and converted to energy or flared.

### 9.5 LANDFILL GAS BARRIERS

A physical barrier system may be necessary to control landfill gas migration. Landfill gas migration in modern sites is inhibited through the construction of a composite liner of compacted clay or enhanced soil, in intimate contact with a flexible membrane liner. In cases where protection of a potential target is necessary from landfill gas migration a barrier may be constructed.

A barrier system may be a vertical barrier system or a horizontal barrier system. A typical example of a vertical barrier is a cement/bentonite slurry cut-off trench. To improve effectiveness a geomembrane should be incorporated into the trench. A horizontal barrier can be formed by jet grouting or chemical grouting. Barriers used to control landfill gas migration are similar to those used for groundwater/surface water control (see Appendix B, Table B.1, Physical cut-off techniques for exclusion of groundwater).

### 9.6 LANDFILL GAS VENTING

Venting systems should only be used where the gas quality is too low for utilisation or flaring, i.e. insufficient concentrations of methane and oxygen. Venting systems can be in the form of vent stacks or gravel filled trenches. Venting systems should be

designed in a manner as to prevent ingress of water. A typical passive venting arrangement is presented in Figure 9.2. Vent stacks may be designed similar to gas wells that are used for gas extraction, this topic is dealt with in Section 9.7.

Vent stacks installed during landfilling should be constructed as to be suitable for connection to the active extraction and utilisation system. The vent stacks should extend upwards through the capping system to provide permanent monitoring and both passive and active extraction locations.

The gas drainage layer in the final capping system and the leachate drainage layer provide pathways for the gas to reach the vent pipes. Figure 9.3 illustrates a gas vent system from the gas drainage layer in the cap system.

### 9.7 LANDFILL GAS COLLECTION

Active control of LFG is implemented through an extraction system with subsequent utilisation or disposal by flaring of the gas. Extraction systems require a gas collection network. This typically comprises gas wells, wellheads, and collection pipes.

Factors which effect collection include:

- quantity of intermediate and top cover used in operation and restoration will influence the extent of lateral migration. Inadequate landfill capping may lead to air being drawn in from the surface of the site and both poisoning the methane producing bacteria as well as diluting LFG being extracted;
- applied suction, this should cause a minimum depression in pressure to limit the effect of gas dilution caused by air ingress;
- leachate level affects the efficiency of the abstraction well. A high leachate level will reduce efficiency; and
- gas well type.

Landfill gas is extracted by means of a suction pump, e.g. booster pump. A landfill gas extraction system may be used for active venting where the quality of gas, i.e. low methane content, is not sufficient to sustain combustion.

FIGURE 9.2: PASSIVE GAS VENTING (INTO WASTE)

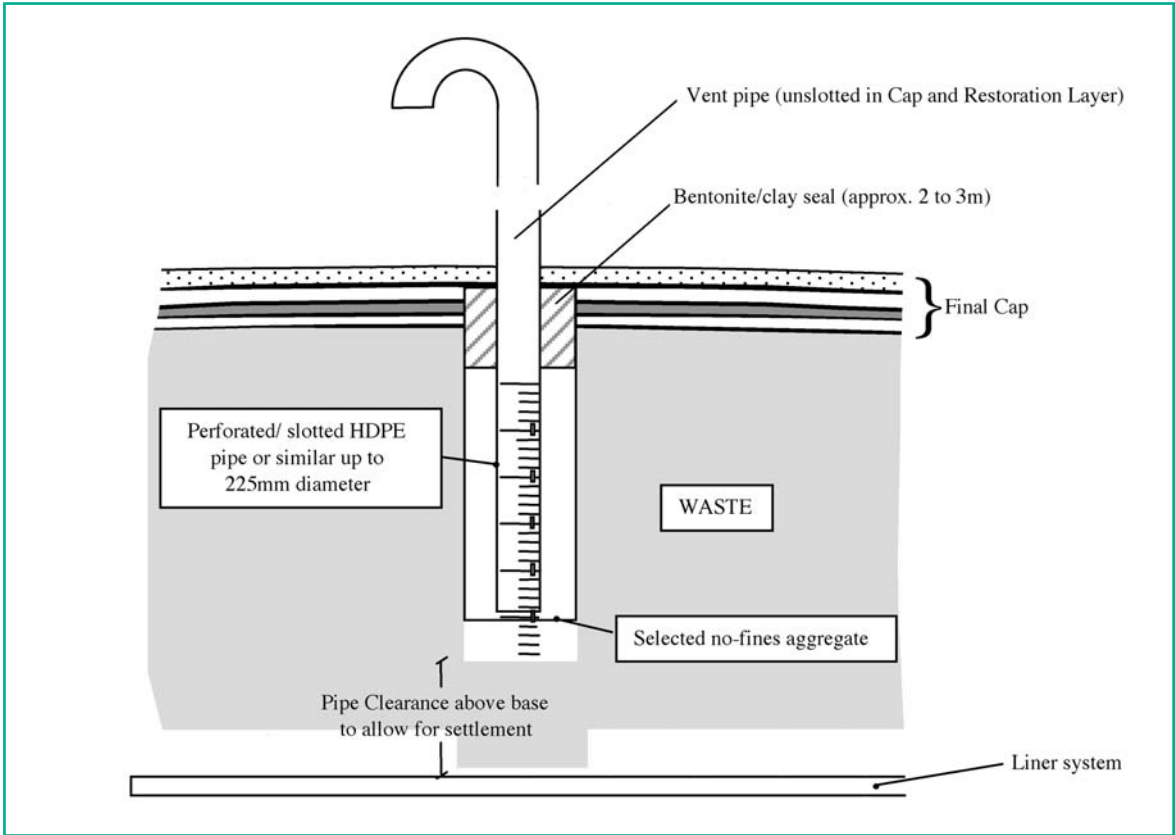
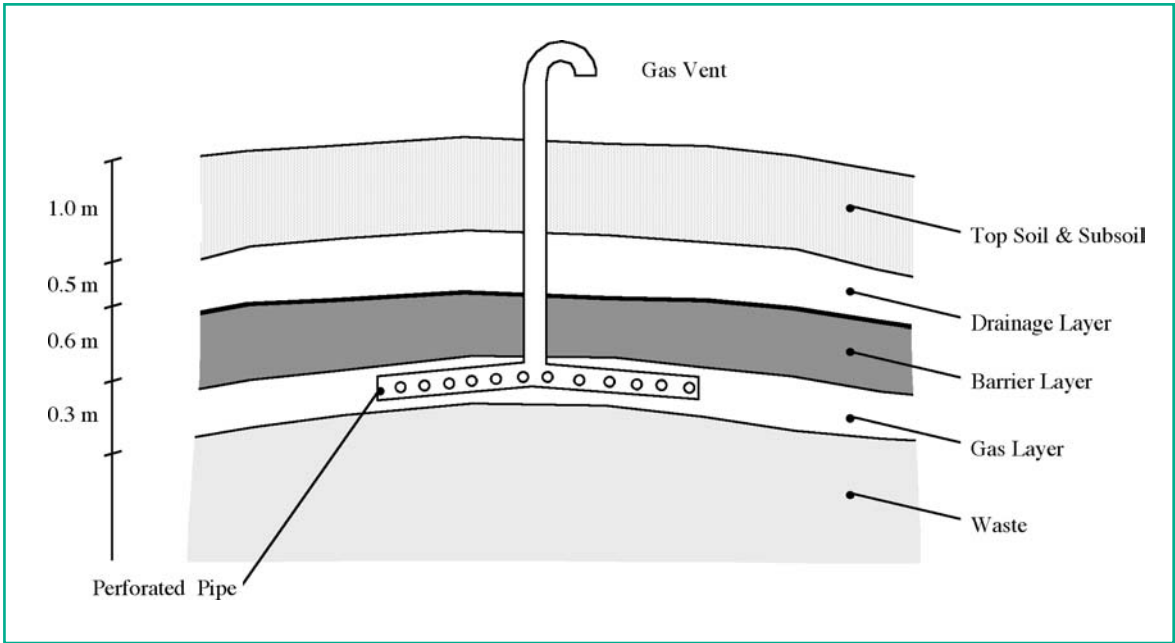

FIGURE 9.3: PASSIVE GAS CONTROL SYSTEM (VENTING TO ATMOSPHERE FROM GAS DRAINAGE LAYER)



### 9.7.1 GAS WELLS

Gas wells may be installed as site filling progresses thereby providing gas control at an early stage of the landfill's development. Alternatively, wells may be drilled after waste emplacement. Even with extensive well arrangements installed during the filling stage, experience shows that vertical wells drilled down to within two metres of the liner are necessary for active gas extraction when the filling is complete.

The most common gas well types are:

- vertical perforated pipe - vertical gas well. Consists of a borehole containing a pipe which has perforations through the wall over the lower part of the pipe length. The pipe is surrounded by coarse aggregate fill;
- horizontal perforated pipe - horizontal gas wells. Consists of perforated pipes laid horizontally in trenches set in the waste or within the gas layer in the final capping system. The pipe is surrounded by coarse aggregate fill;
- hybrid types. Consist of an array of shallow depth perforated vertical wells connected to a single offtake point by lengths of buried horizontal pipe which may also be perforated; and
- gabion well. Consist of aggregate filled excavations set in the waste from which gas is drawn off through a perforated pipe located within the aggregate.

Examples of each well type are given in Figures 9.4 to 9.7. The design of any gas well should include allowance for settlement of the waste within the landfill and sufficient space should be left between the bottom of the well and the landfill liner to reduce the risk of damaging the liner. Typically gas wells are drilled to 75% of the waste depth. Connections to pipework should also provide flexibility to allow for settlement of the waste. The material surrounding the perforated section of the pipe should be a non carbonaceous aggregate.

Gas wells constructed as filling progresses usually have a minimum diameter of 500 mm, a diameter of 600 - 800mm is preferred. Gas wells retrofitted after filling are typically drilled to 250-300mm diameter. Gas wells formed during filling are therefore normally larger than those retrofitted. The slotted well pipe typically has a minimum diameter of 160

mm. The well pipe material is usually either HDPE, MDPE or polypropylene.

The well spacing necessary to achieve gas collection is site specific. Vertical gas wells are normally spaced at between 20m and 60m centres (with 40m being the industry norm in the UK). A suitable design is to size pipework for wells on the basis of each ten metres of perforated well producing a flowrate of fifty cubic metres per hour. The combined flowrate from individual wells then must be taken into account for the collector system (ETSU B/LF/00474/REP/1).

Specifications that may be considered in vertical gas well selection include:

- minimum well pipe diameter 100mm;
- sealing of the upper portion of the gas well casing from the ground surface to a depth of at least 3m with bentonite;
- a minimum of 17% of the pipe surface area should be cut away to allow the ingress of gas;
- slot widths should be 3-5mm;
- pipes should be surrounded by a suitably sized no fines aggregate with well rounded grains of 4-6 times slots width (aggregate size of 12-30mm);
- the best configuration of slots are horizontal, i.e. at right angles to the pipe axis, this reduces the collapse strength of the pipe by 30-40% compared to vertical slots which reduce the strength by 65-70%; and
- wells should be located between 20m and 100m apart depending on whether they are intended for utilisation or control.

### 9.7.2 WELL HEADS

Wellheads are fitted to the top of gas wells to control the extraction of gas. The material typically used to make wellheads is polyethylene (PE). An example of a typical wellhead is shown in Figure 9.8. Wellheads should be encased in lockable headwork's to prevent vandalism. They should be joined to connecting pipework using flexible piping to allow for settlement. Wellheads have been developed to cover a number of aspects and components vary depending on the required functions. These include:

- flow rate measurement fittings, to allow for the flow from individual wells to be monitored;
- flow regulators;
- dewatering wellheads;
- combined leachate and gas extraction; and
- telescopic fittings to account for movement of the landfill surface with site settlement.

Wellheads should include provisions for monitoring gas quality and suction pressure.

### 9.7.3 COLLECTOR PIPES

A collection pipe network is needed to convey the gas from the point of generation or collection to the point of thermal destruction or energy production. The pipeline material should be chemically resistant to landfill gas, condensate and leachate as well as having appropriate mechanical strength to withstand loading and ground/waste settlement. The materials which are deemed most suitable are polyethylene (MDPE and HDPE), and polypropylene. The pipework should be sized to allow for maximum possible gas flow rate from the site.

It is recommended that pipes be laid to a minimum fall of 1:30 to assist drainage of condensate. It may be necessary to lay pipes over flat terrain in a saw-tooth configuration to achieve the required minimum fall. Dewatering points should be provided at all drop legs in such a system. The pipeline should have sufficient valves to allow isolation of sections. Pressure testing of the collection pipe network should be carried out to ensure integrity of the pipe material and of joints. All pipes laid underground should have a minimum cover of 600mm over the top of the pipe.

### 9.7.4 CONDENSATE REMOVAL

When LFG enters cooler zones condensate may be generated which may be corrosive and may contain volatile organics. The main constituents in condensates are volatile fatty acids, ammoniacal-N and in some samples metals such as zinc or iron that result from corrosion of galvanised or metallic components of gas collection systems. Trace quantities of atrazine, simazine and pentachlorophenol were detected in a UK DOE study (UK DOE, 1995b).

The removal of condensate from the pipeline is necessary to prevent blockages and restriction of gas flow. This can be achieved by use of syphon tubes (Figure 9.9) or by condensate knock out drums (Figure 9.10). The syphon tube consists of water seal leg and drip tube through which the condensate flows to a ground soakaway. The knock out drums are used when a high condensate volume is expected or when the levels of groundwater or leachate are expected to rise above the gas collection pipe network. The knock out drum consists of a drum which allows expansion of the gas flow with a resultant drop out of condensate which may be collected within the drum and discharged or pumped to a suitable reception point. Where condensate is collected, it should be diverted to the leachate collection system.

### 9.7.5 EXTRACTION PUMPS

Centrifugal compressors are normally used for gas extraction. They are available in a range of sizes typically between 150m<sup>3</sup>/hr and 3000m<sup>3</sup>/hr. Extraction plant is typically designed on a modular basis to provide cost effective and flexible solutions. Parameters that should be specified for a landfill gas extraction system include; inlet suction and outlet pressure; flow capacity; and power consumption. Flame arrestors should be fitted so that if pumping a gas/air mixture within the explosive range the risk of propagation of an explosion is minimised. Instrumentation to allow regular rebalancing of the gas flows from each well is also required.

A suction pressure of up to 100mb may be required. The pressure required at the outlet of the extraction plant is a function of the use to which the fuel is to be put and the pipework sizes that will be involved (ETSU B/LF/00474/REP/1). Centrifugal blowers typically have a pressure lift of 50-100 mbar (single stage) and these therefore restrict well-head suctions to (say) 25mbar. Sites which require higher gas delivery pressure for utilisation purposes will use other types of gas compressor.

Other extraction equipment that may be considered include:

- liquid ring compressors;
- regenerative gas boosters;
- roots-type blowers;

- reciprocating compressors;
- sliding vane compressors; and
- multi-stage centrifugal gas boosters.

#### 9.7.6 COMMISSIONING/ DECOMMISSIONING

Commissioning and decommissioning of control systems are potentially hazardous operations and should be carried out and be supervised by appropriate qualified persons.

### 9.8 UTILISATION OF LANDFILL GAS

The utilisation of landfill gas as an energy resource may be a commercially viable proposition and can offset some of the costs of control. Gas utilisation depends on the quality of the gas, the gas yield and on the economics of production to available market. The potential end use of the LFG depends on the methane content of the gas. For safety reasons, the collection and utilisation of methane gas must operate above the upper explosive limit. Figure 9.11 illustrates the landfill gas process from generation to utilisation.

It is widely accepted that the minimum amount of landfilled biodegradable waste required to sustain a commercially viable landfill gas electricity scheme is about 200,000 tonnes ("*Technology status report 017 dti*" (Department of Trade and Industry 1995)). Without a well constructed cap it is unlikely that the utilisation of LFG will be a realistic commercial possibility, unless the site is very deep and contains a volume in excess of one million cubic metres (ETSU B/LF/00474/REP/1). A 40% collection efficiency over the lifetime of the landfill appears to be the practical maximum (ETSU B/LF/00325/REP).

As with the siting of flaring equipment, gas extraction/utilisation plants should take into account sensitive receptors, prevailing wind etc and should be located so as to minimise odour nuisance and visual intrusion.

#### Direct Uses

The following are applications where LFG can be used directly:

- boiler firing;
- brick burning in kilns;
- cement manufacture;
- stone drying;
- district heating;
- greenhouse heating;
- augmenting national gas supply; and
- vehicle fuel.

The size of direct use schemes typically range between 0.5 - 3.5MW. Minimum methane concentration will vary depending on the application. In order to use the gas directly there must be an available market.

#### Power generation

Normally the size of power generation schemes are in the range 1MW to 5MW. Typically some 600/700m<sup>3</sup> of landfill gas (containing 50% methane) are required to generate 1 MW of electricity. The type of plant for power generation will depend on the quantity and quality of gas generated. Power generation is feasible at a landfill when the methane content range is 28% to 65%.

Power generation plants used include gas turbines, dual-fuel engines and spark ignition engines. Minimum methane content for these plants vary but typically around 35% methane content is required. Gas turbines start at about 3MW and are suitable for larger schemes with gas flow rates in excess of 2500m<sup>3</sup>/hr.

As with the flare unit, products of combustion from the utilisation plant should be tested to verify the predicted performance is being achieved. Specific limits for engine emissions may be set at the time of licensing, but as a general guide emission standards such as TA Luft may be referred too.

### 9.9 LANDFILL GAS FLARES

If the gas quality is too low for use as fuel then it can be flared. Typically a methane content of at least 20% by volume is specified for operation of a landfill gas flare unit. A flare system may also be used to burn off excess gas or to act as a standby during periods of plant shutdown.

There are two basic types of flare unit; an elevated stack; and a shrouded flare type. Landfill gas should be flared at a temperature range of between 1000°C and 1200°C to remove minor constituents in the landfill gas. For adequate destruction, combustion retention time is typically between 0.3 and 0.6

seconds. With elevated stacks it is not possible to obtain extended residence times at elevated temperatures. The shrouded flare type can hold the gas at the design temperature for a specified period of time within a combustion chamber of adequate volume. Figure 9.12 is an example of a schematic diagram of a landfill gas flare.

Whilst the combustion of landfill gas reduces the risk of uncontrolled landfill gas emission and explosion, the potential health and environmental impacts of emissions from flares (and from other combustion processes for landfill gas use) also have to be taken into account. Open flares should only be used as a temporary measure as they do not achieve the emission standards outlined below. Temporary use may include for example an assessment of actual gas flow rate for a limited period of no more than 6 months.

The height of the flare is also important. Tall flares are preferable to shorter flares as:

- they are better able to induce sufficient combustion air;
- they are more likely to provide an adequate retention time for the entire gas stream;
- the temperature distribution is more uniform; with short wide stacks there is an increased risk of poor mixing of gases near the walls. Thus tall flares are less likely to develop cold spots where combustion will be poor; and
- they allow better dispersion of the off-gases into the atmosphere.

As with the siting of gas extraction/utilisation plants, flaring equipment should take into account sensitive receptors, prevailing wind etc. and should be located so as to minimise odour nuisance and visual intrusion.

The products of combustion from the flare unit should be tested to verify that the predicted performance is being achieved. Specific limits for flare units may be set at the time of licensing, but as a general guide emission standards such as those set out below and TA Luft may be referred to. An example of monitoring requirements for a flare unit are presented in Table 9.2.

The flare system should not exceed the following emission concentrations when referred to NTP and 3% oxygen:

|                                       |                      |
|---------------------------------------|----------------------|
| Carbon monoxide (CO)                  | 50mg/m <sup>3</sup>  |
| Oxides of nitrogen (NO <sub>x</sub> ) | 150mg/m <sup>3</sup> |
| Unburnt hydrocarbons                  | 10mg/m <sup>3</sup>  |

## 9.10 LANDFILL GAS MONITORING

Minimum requirements for monitoring are outlined in the Agency's Manual '*Landfill Monitoring*'. A typical monitoring borehole is presented in Figure 9.13. It is essential that monitoring points be established on the perimeter of the site and between the site and locations such as buildings that may be at risk from landfill gas migration. Investigations should identify likely monitoring point locations. To establish if there are any other sources of gas around the site monitoring should be undertaken prior to waste emplacement, in accordance with the Monitoring Manual.

TABLE 9.2: MONITORING COMBUSTION PRODUCTS FROM FLARE UNITS

| Level  | Type                       | Inlet gas  | Emissions  |
|--------|----------------------------|--|--|
| First  | Routine inputs and outputs | CH <sub>4</sub> , CO <sub>2</sub> , O <sub>2</sub> | Bulk composition (O <sub>2</sub> , CO)<br>Temperature and gas flow rate  |
| Second | Combustion products        | As above   | Bulk composition (O, CO, NO <sub>x</sub> , CO <sub>2</sub> , THC)<br>Temperature, retention time and gas flow rate |
| Third  | Trace species              | As above   | As above plus HCL, HF, SO <sub>2</sub> and a range of oxygenated and sulphuretted organics                         |

Notes:

1. first level monitoring should be carried out regularly since it provides the basic information needed for controlling the flare.
2. second level monitoring should be carried out periodically or when there is some significant change in, for example, the composition of landfill gas. It provides more information about the completeness of combustion products and the major emissions.
3. third level monitoring is likely to be infrequent but should be considered for large flares close to population centres or other environmentally sensitive areas since it is targeted at good indicators of potentially hazardous components in flare emissions.



Buildings within and in the vicinity of landfill sites should be assessed in accordance with the *'Protection of New Buildings and Occupants from Landfill Gas'* (DoE, 1994). In addition onsite buildings should be fitted with alarms as a precautionary measure to indicate if trigger levels are exceeded. In such instances emergency monitoring should be undertaken to identify the point of gas ingress and control measures should be implemented to prevent further ingress.

Typical instrumentation for monitoring LFG is given in Appendix E, Table E.2.

### **9.11 LANDFILL GAS SAFETY**

The flammability, toxicity, and asphyxiate characteristics of landfill gas requires personnel involved in the monitoring, operation, construction or any other aspect of a gas management system to be adequately trained. A written safe system of work with rehearsal emergency procedures should be provided before work on landfill gas management system commences.

Stringent safety measures should be incorporated into equipment for landfill gas collection, utilisation, flaring and venting. This should include flame arrestors, automatic slam shut valves, and a standby flarestock which would burn off any excess gas should an engine fail.



FIGURE 9.4: EXAMPLE OF A VERTICAL GAS WELL ARRANGEMENT

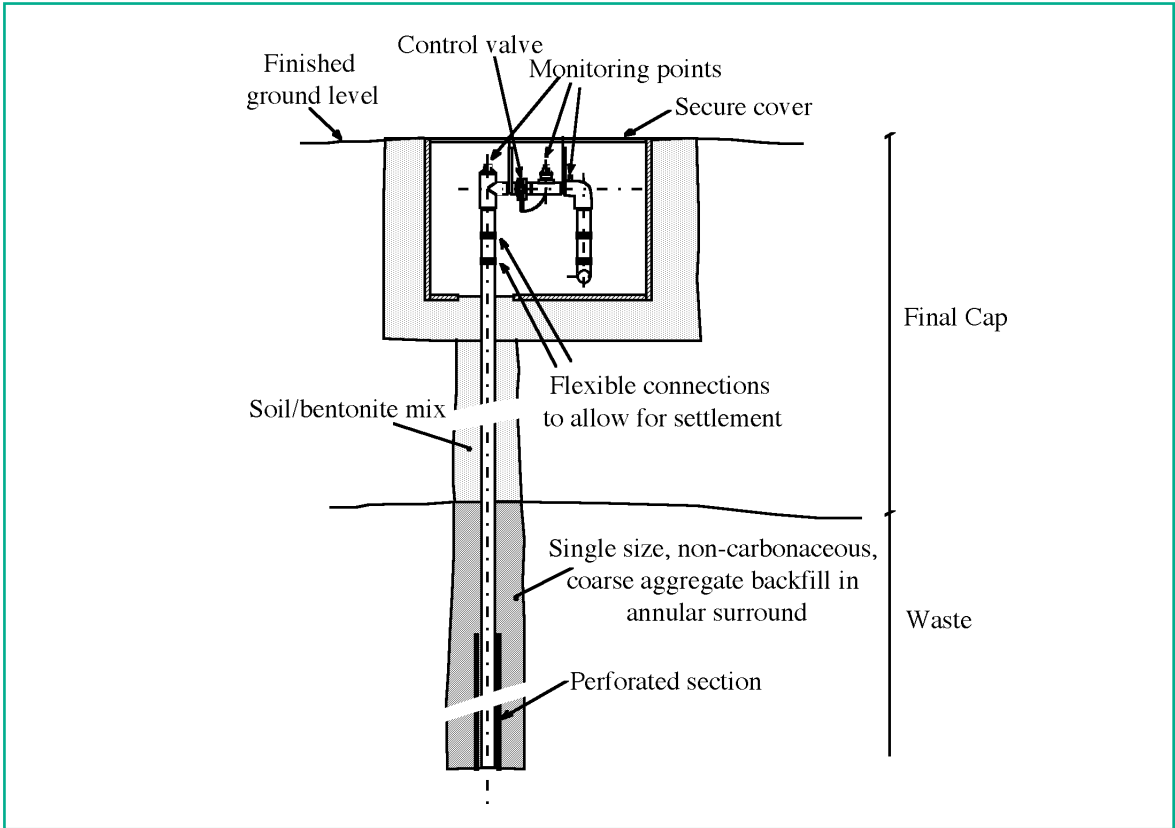

FIGURE 9.5: EXAMPLE OF A HORIZONTAL WELL

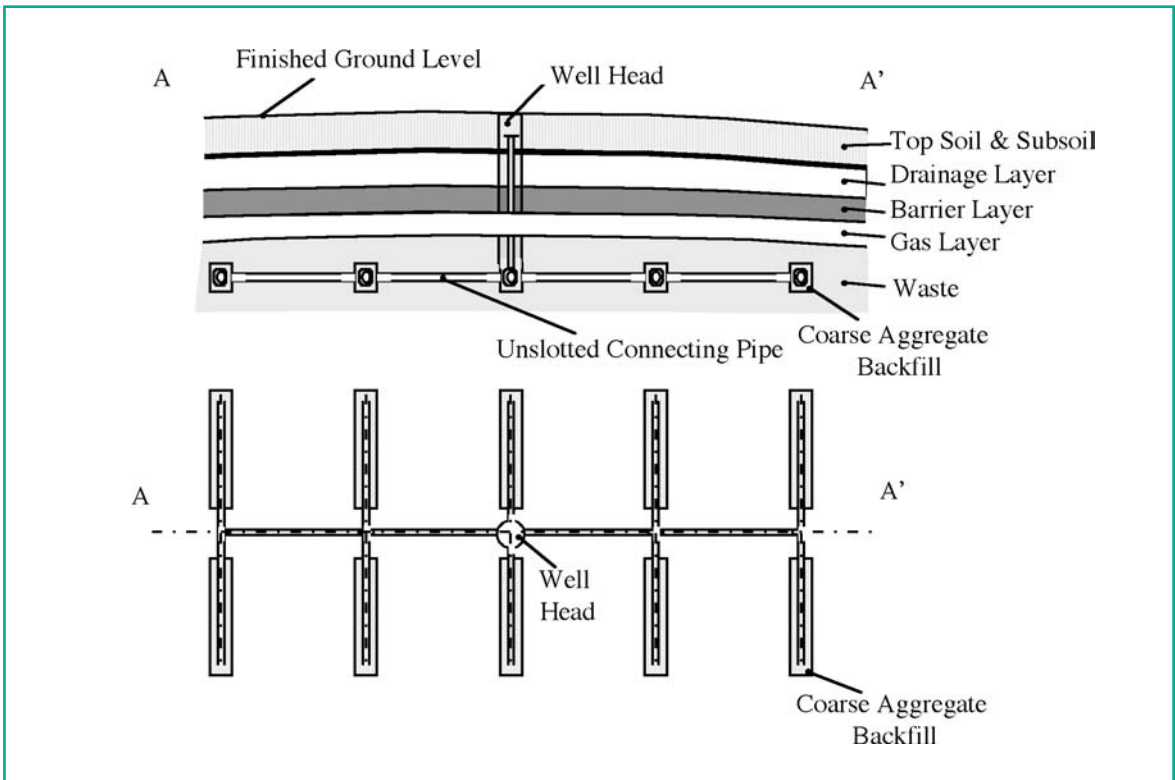

FIGURE 9.6: EXAMPLE OF A HYBRID WELL ARRANGEMENT

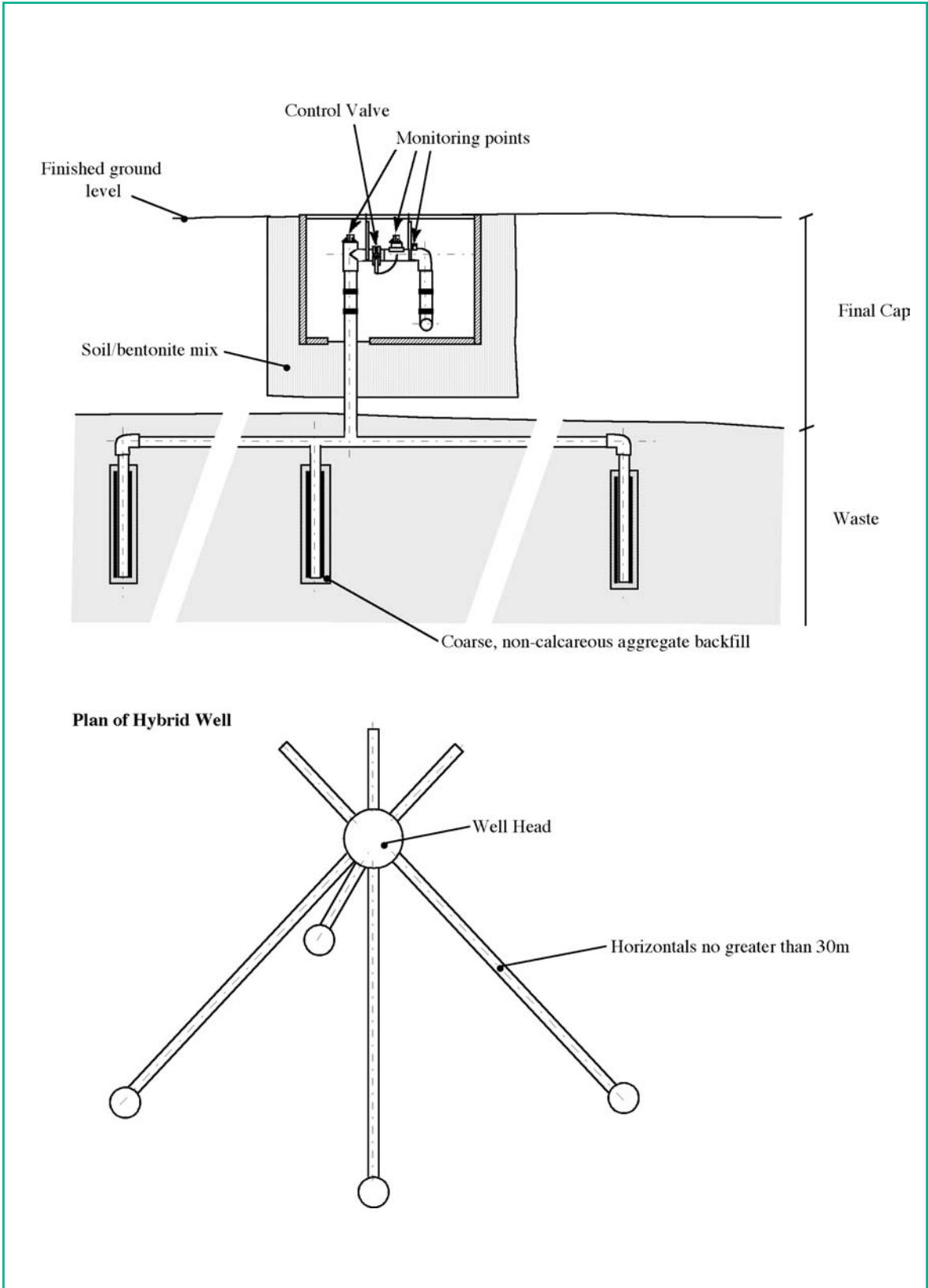

FIGURE 9.7: EXAMPLE OF A GABION GAS WELL ARRANGEMENT

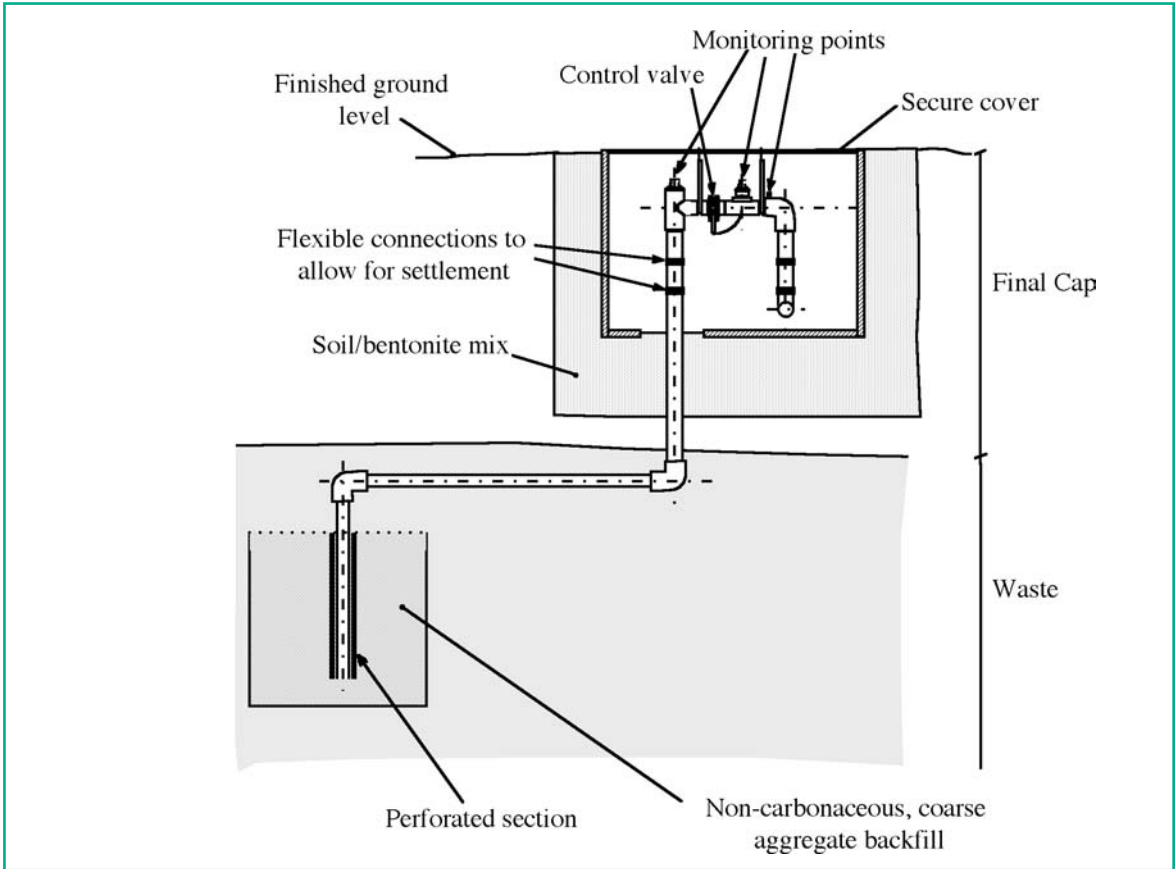

FIGURE 9.8: TYPICAL WELL HEAD FOR LANDFILL GAS

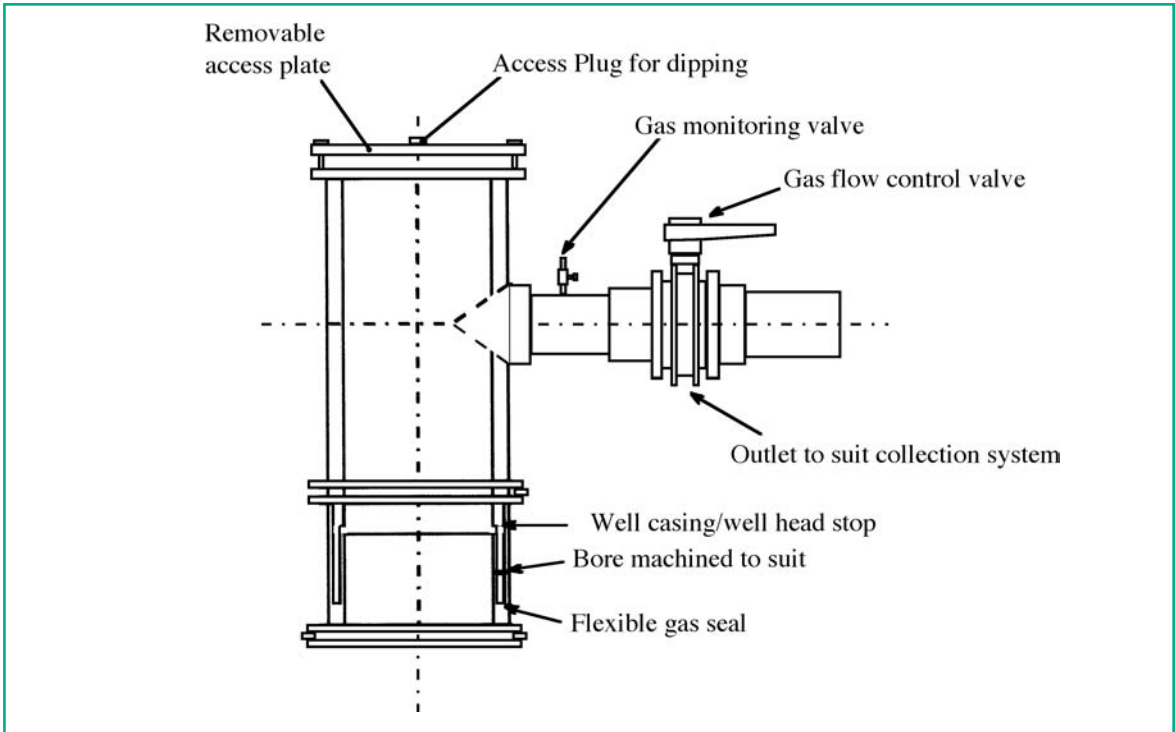

FIGURE 9.9: LANDFILL GAS CONDENSATE TRAPS

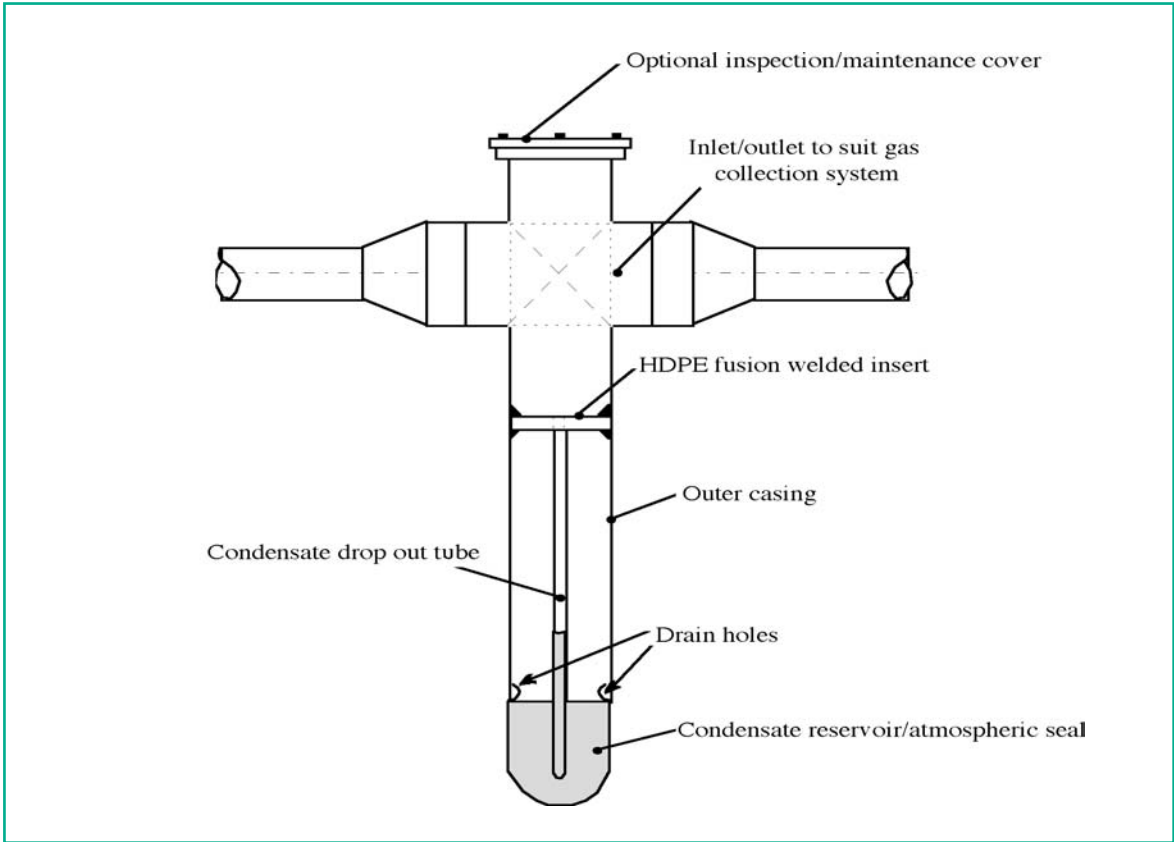

FIGURE 9.10: TYPICAL CONDENSATE RESERVOIR COMPLETE WITH SYPHON

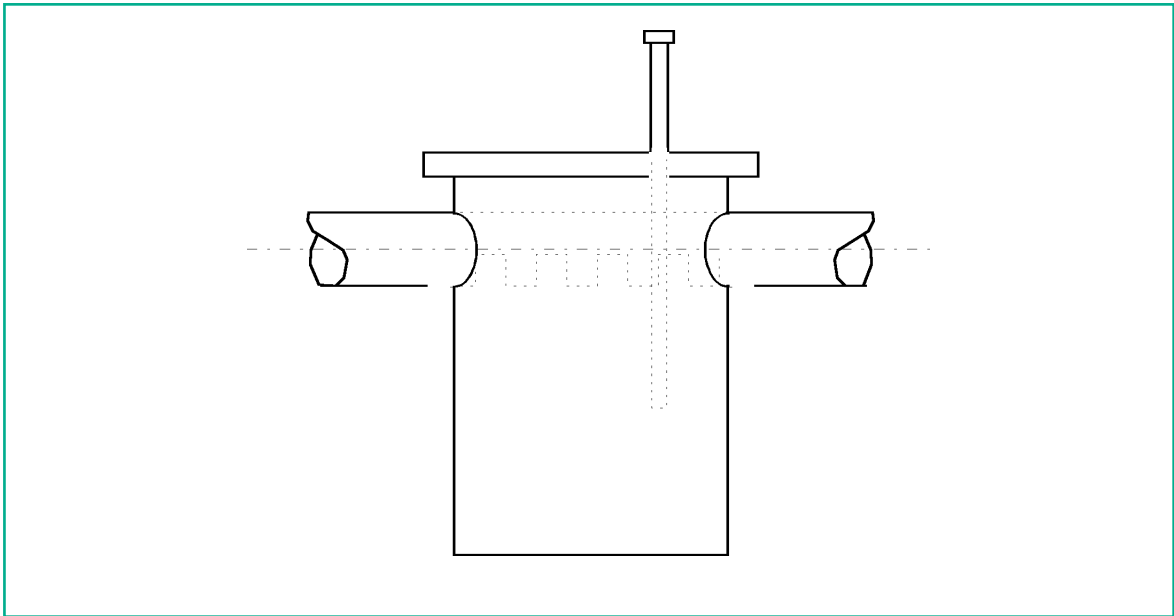

FIGURE 9.11: ILLUSTRATION OF LANDFILL GAS DEVELOPMENT & PRODUCTION OPTIONS

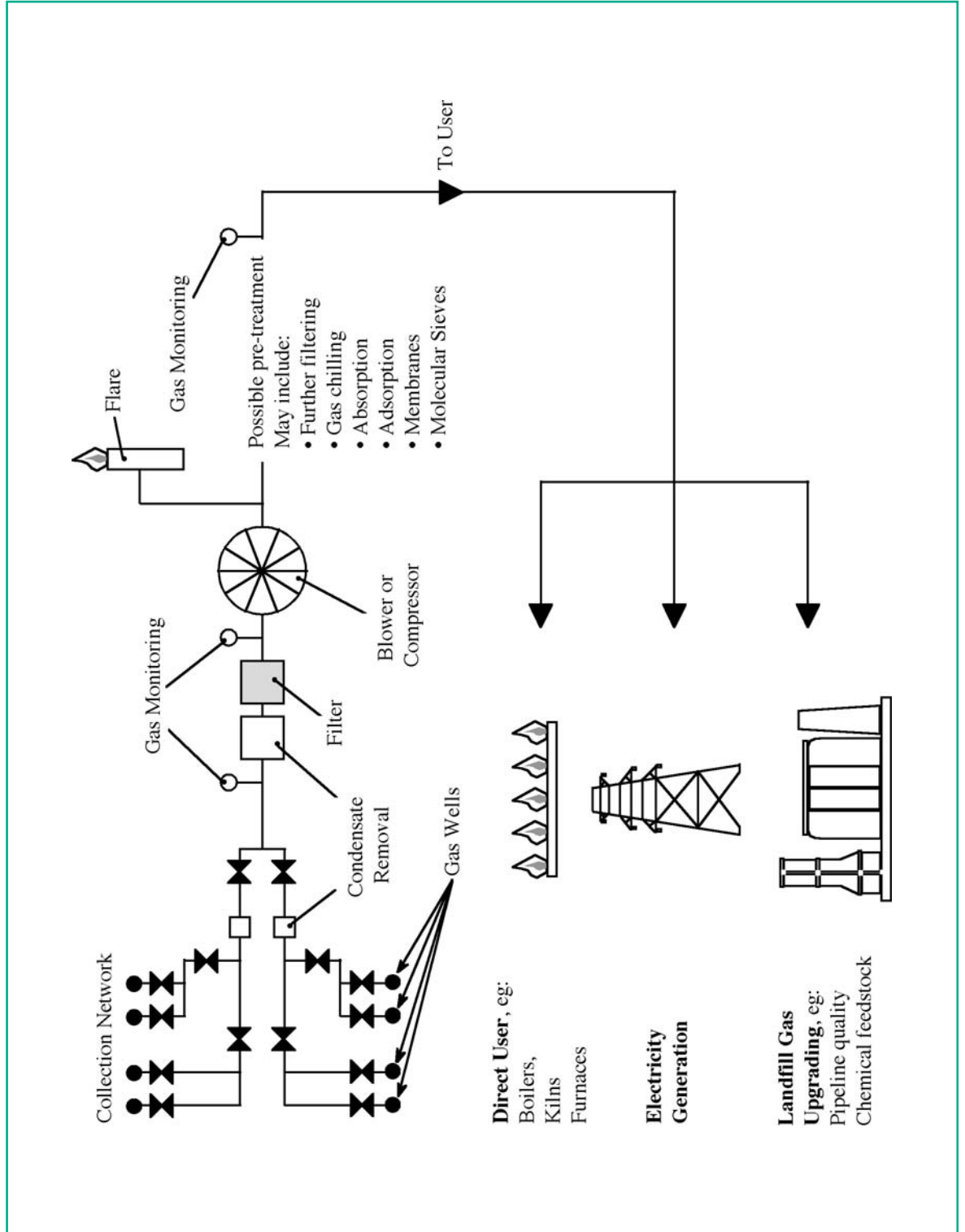

FIGURE 9.12: SCHEMATIC DIAGRAM OF A LANDFILL GAS FLARE

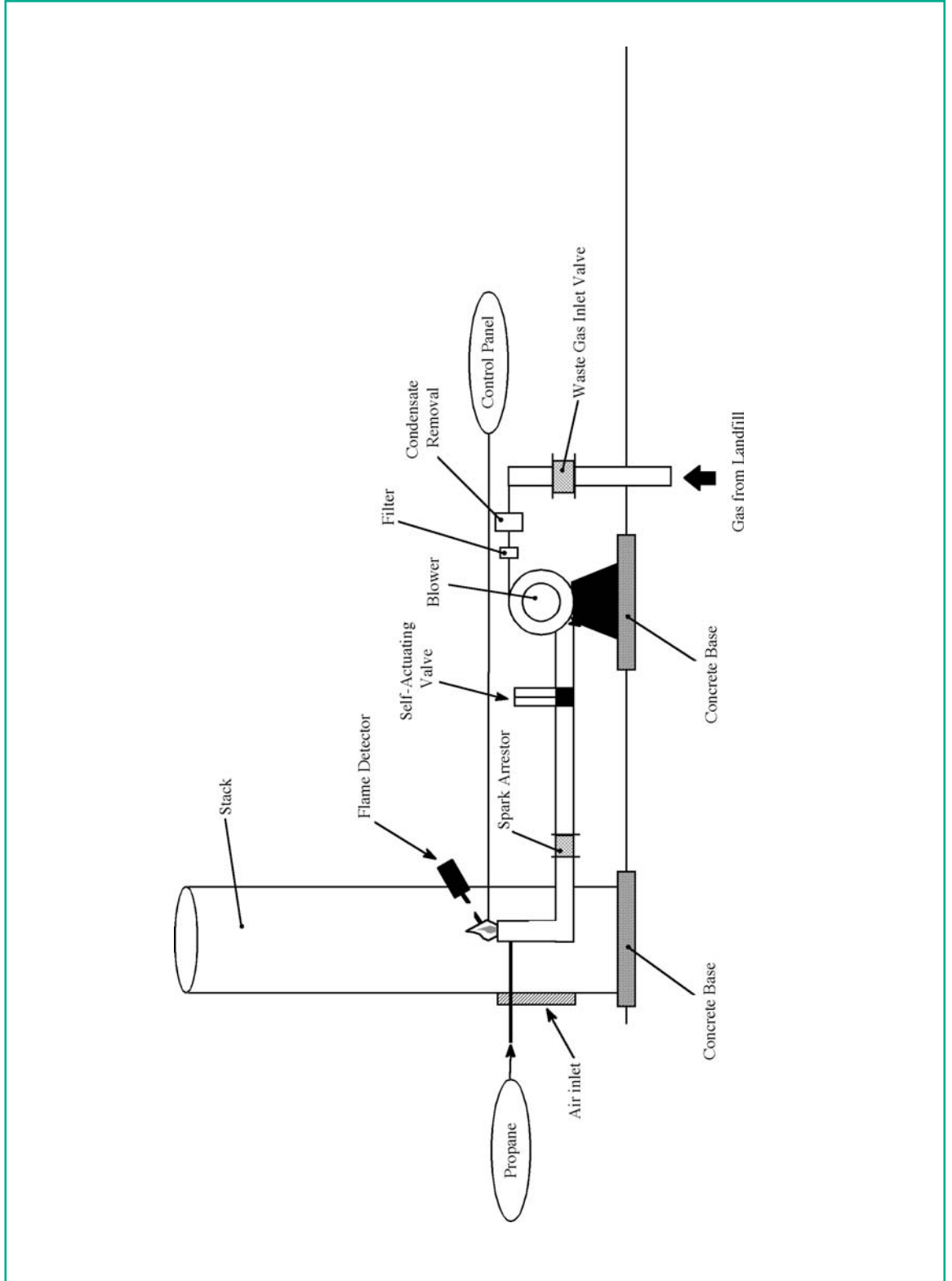
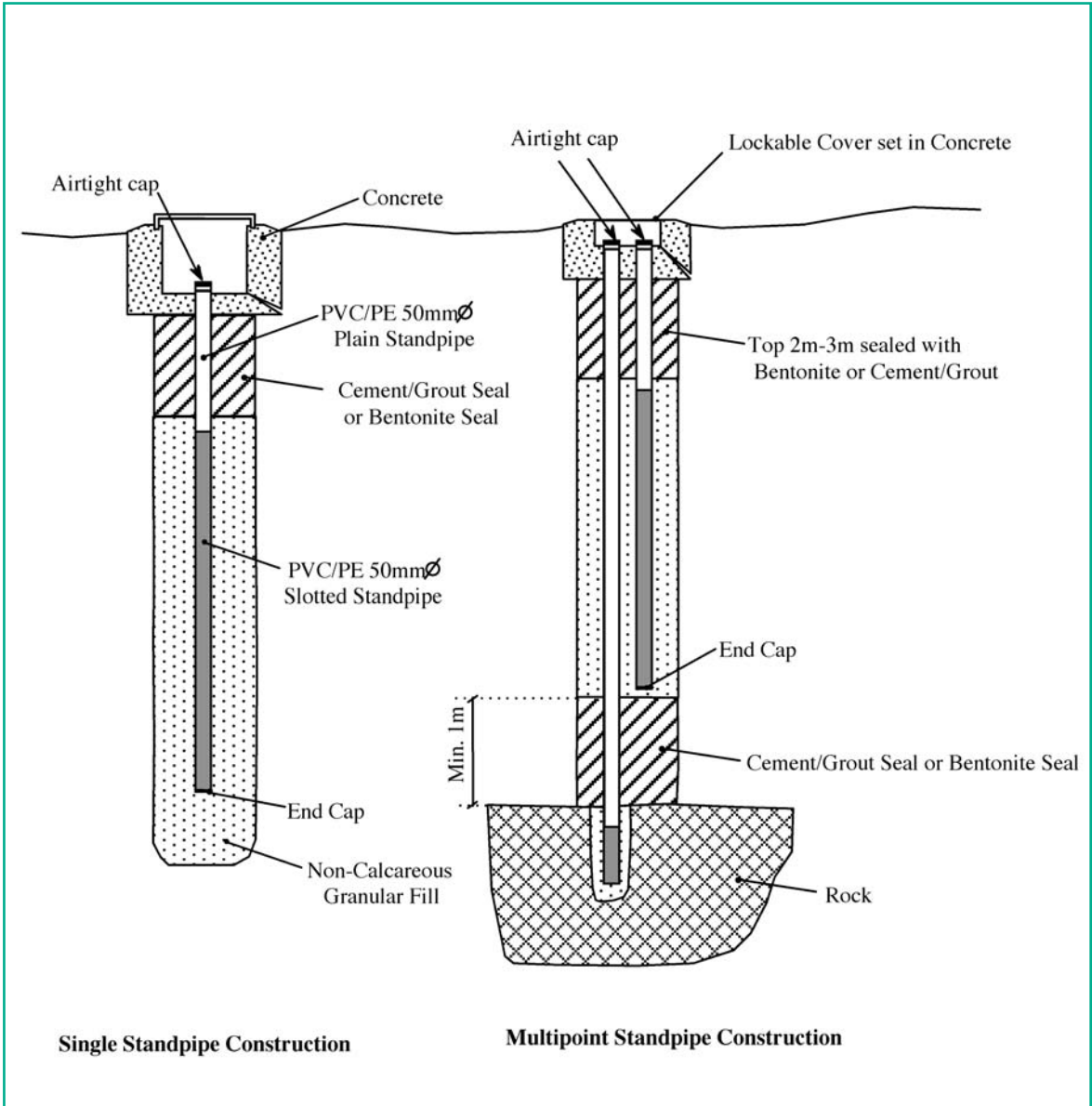

FIGURE 9.13: TYPICAL LANDFILL GAS MONITORING BOREHOLE (OUTSIDE WASTE BODY)





## 10. CAPPING DESIGN & CONSTRUCTION

### 10.1 INTRODUCTION

The capping system comprises engineering and restoration layers. The makeup of the restoration layers must be consistent with the proposed afteruse of the facility. Further guidance on restoration and aftercare is provided in the Agency's Manual '*Landfill Restoration and Aftercare*'.

### 10.2 OBJECTIVES OF CAPPING

The main objectives in designing a capping system are to:

- minimise infiltration of water into the waste;
- promote surface drainage and maximise run off;
- control gas migration; and
- provide a physical separation between waste and plant and animal life.

The capping system normally includes a number of components which are selected to meet the above objectives. The principal function of the capping system is to minimise infiltration into the waste and consequently reduce the amount of leachate being generated.

### 10.3 CAPPING SYSTEM DESIGN CONSIDERATIONS

The designer of the capping system should consider:

- temperature and precipitation extremes;
- the effects of roots and burrowing animals on its integrity;
- robustness against settlement stresses;
- stability of slopes;
- vehicular movement;
- vehicle access tracks and public footpaths;
- surface water drainage;
- leachate recirculation;

- installation of gas well heads and collection pipework;
- installation of leachate collection manholes and pipework;
- ease of repair;
- aesthetic appearance; and
- end use.

### 10.4 COMPONENTS OF CAPPING SYSTEMS

The components of a landfill capping system may include:

- topsoil;
- subsoil;
- drainage layer;
- barrier (infiltration) layer;
- gas drainage layer; and
- system for leachate recirculation (see Section 7.5)

The components of the capping system and the materials to be used should be evaluated on a case by case basis. Not all components will be necessary for every site.

#### 10.4.1 TOPSOIL AND SUBSOIL

The primary function of the topsoil is to enable the planned afteruse to be achieved. The topsoil should be uniform and have a minimum slope of 1 to 30 to prevent surface water ponding and to promote surface water run off. The maximum slope will depend on the afteruse but it is recommended that the slope be no greater than 1 in 3. Further details on slopes of land in relation to use are provided in the manual on '*Landfill Restoration and Aftercare*'.

The topsoil should be thick enough to:

- accommodate root systems;
- provide water holding capacity to attenuate moisture from rainfall and to sustain vegetation

through dry periods;

- allow for long term erosion losses; and
- prevent desiccation and freezing of the barrier layer.

It is recommended that the combined thickness of the topsoil and the subsoil should be at least 1m.

#### 10.4.2 DRAINAGE LAYER

Drainage layers are used below the topsoil/subsoil and above the barrier layer to:

- minimise the head of water on the underlying barrier layer, which reduces percolation of water through the capping system;
- provide drainage of the overlying topsoil and subsoil, which increases the water storage capacity of these layers and helps to minimise erosion by reducing the time during which the surface and protection layer materials remain saturated with water; and
- increase slope stability by reducing pore water pressure in the overlying soil materials.

Water collected by the drainage layers will be discharged to surface waters. The drainage layer can consist of granular material, of minimum thickness 0.5m or a geosynthetic drainage medium. The hydraulic conductivity should be equal to or greater than  $1 \times 10^{-4} \text{m/s}$ . The slopes for the drainage layer in the final capping system should be no less than 4%, i.e. 1 vertical : 25 horizontal, to assist gravity drainage.

#### 10.4.3 BARRIER LAYER

The principal functions of the barrier layer are to:

- control leachate generation through minimising infiltration of water; and
- control movement of landfill gas.

The barrier layer will usually consist of a compacted low hydraulic conductivity mineral layer or a synthetic layer such as a geomembrane or geosynthetic clay, similar in nature to those used as liners. The minimum thickness of the natural compacted layer should be 0.6m with a hydraulic conductivity of  $1 \times 10^{-9} \text{m/s}$ , where a geosynthetic material is used it should provide equivalent protection.

#### 10.4.4 GAS COLLECTION LAYER

The gas collection layer transmits gas to collection points for removal and disposal or utilisation. Materials that can be used for gas collection include sand or gravel with soil or geotextile filters, geotextile drainage fabrics, and geonet drains with geotextile filters. The thickness of natural material gas collection layers are usually between 150mm to 300mm. Further information on the pipework required to remove the collected gases is provided in Chapter 9.

#### 10.4.5 FILTER MATERIAL

Filter layers may be required at the boundaries of coarse granular layers or geosynthetic drainage layers in order to prevent the ingress of fines. If a coarse drainage layer is to be placed onto a geomembrane, a protection layer is required to protect the geomembrane from puncture and over stressing.

### 10.5 RECOMMENDED CAPPING SYSTEMS

The following sections provide recommendations on capping systems for non-hazardous, hazardous and inert landfills. Minimum requirements recommended are illustrated in Figure 10.1. Alternative systems may be used but typically these should meet the minimum requirements set out below.

#### 10.5.1 HAZARDOUS LANDFILL CAPPING SYSTEM

The capping system for this type of facility should consist of at minimum the following:

- top soil (150 - 300mm) and subsoil of at least 1m total thickness;
- drainage layer of 0.5m thickness having a minimum hydraulic conductivity of  $1 \times 10^{-4} \text{m/s}$ ; and
- a compacted mineral layer of a minimum 0.6m thickness having a hydraulic conductivity of less than or equal to  $1 \times 10^{-9} \text{m/s}$  in intimate contact with a 1mm flexible membrane liner.

Consideration should be given to the inclusion of a gas collection layer of natural material or a geosynthetic layer.

### 10.5.2 NON-HAZARDOUS BIODEGRADABLE LANDFILL CAPPING SYSTEM

The capping system for this type of facility should consist of at minimum the following:

- top soil (150 - 300mm) and subsoil of at least 1m total thickness;
- drainage layer of 0.5m thickness having a minimum hydraulic conductivity of  $1 \times 10^{-4}$  m/s;
- compacted mineral layer of a minimum 0.6m thickness having a hydraulic conductivity of less than or equal to  $1 \times 10^{-9}$  m/s or a geosynthetic material (e.g. GCL) or similar that provides equivalent protection; and
- a gas collection layer of natural material (minimum 0.3m) or a geosynthetic layer.

Consideration should be given to the inclusion of a flexible membrane liner in the capping system. The inclusion of leachate recirculation systems (Section 7.5) should be considered for landfill sites that have liner systems in place.

### 10.5.3 INERT LANDFILL CAPPING SYSTEM

The capping system for an inert landfill should consist of:

- top soil and subsoil, thickness dependent on afteruse but to a minimum of 0.5m.

### 10.6 CAP STABILITY

It may be necessary to carry out an analysis of the cap stability. This may be especially the case for

- steep restoration slopes (steeper than 1:6); and
- components that may have a low friction interface (e.g. interface between a geomembrane and a wet compacted clay).

Stability will depend on the shear strength properties of the soils, waste, and geosynthetic components used in the cap system. Additionally, the presence of water acts as a destabilising agent in reducing the strength and increasing the destabilising force.

Stability is usually expressed in terms of 'factor of safety' which can be defined as the shear strength required to maintain a condition of limiting equilibrium compared with the available shear

strength of the material in question. If the factor of safety is less than one the system is obviously unstable.

A number of methods are available for analysing slope stability. Slope stability should be analysed using conventional limit state analysis. These include Fellenius method and Bishops method. Computer programs (e.g. slope) are usually used to analyse the data.

To improve slope stability geogrids or geotextile reinforcement layers may be incorporated into the cap.

### 10.7 SETTLEMENT

Settlement of the completed waste mass will occur as a result of the decomposition of biodegradable waste within the landfill. Settlement values of between 10 and 25% can be expected for municipal waste landfills. The majority of settlement occurs over the first five years. Settlement continues, gradually reducing with time, until the waste is stabilised.

The degree and rate of waste settlement are difficult to estimate. Estimates of settlement can be obtained through conventional consolidation methods. Total settlement should be estimated in order to predict surcharge contours.

To compensate for differential settlement the capping system may be designed with greater thickness and/or slope. If geomembranes are used they should be able to withstand high tensile strains induced by differential settlement, LLDPE (linear low density polyethylene) is particularly suitable. Even if precautions are taken, post closure maintenance may still require regrading of the final capping due to total and differential settlement.

To avoid damage to the final cap system, it may be necessary to wait a number of years, particularly if large scale and uneven settlement is expected. A temporary cap may have to be installed between completion of filling and installation of the final cap. The temporary cap should be at least 0.5m thick. Components of the temporary cap should be capable of meeting the objectives outlined in Section 10.2.

FIGURE 10.1: LANDFILL CAPPING SYSTEMS

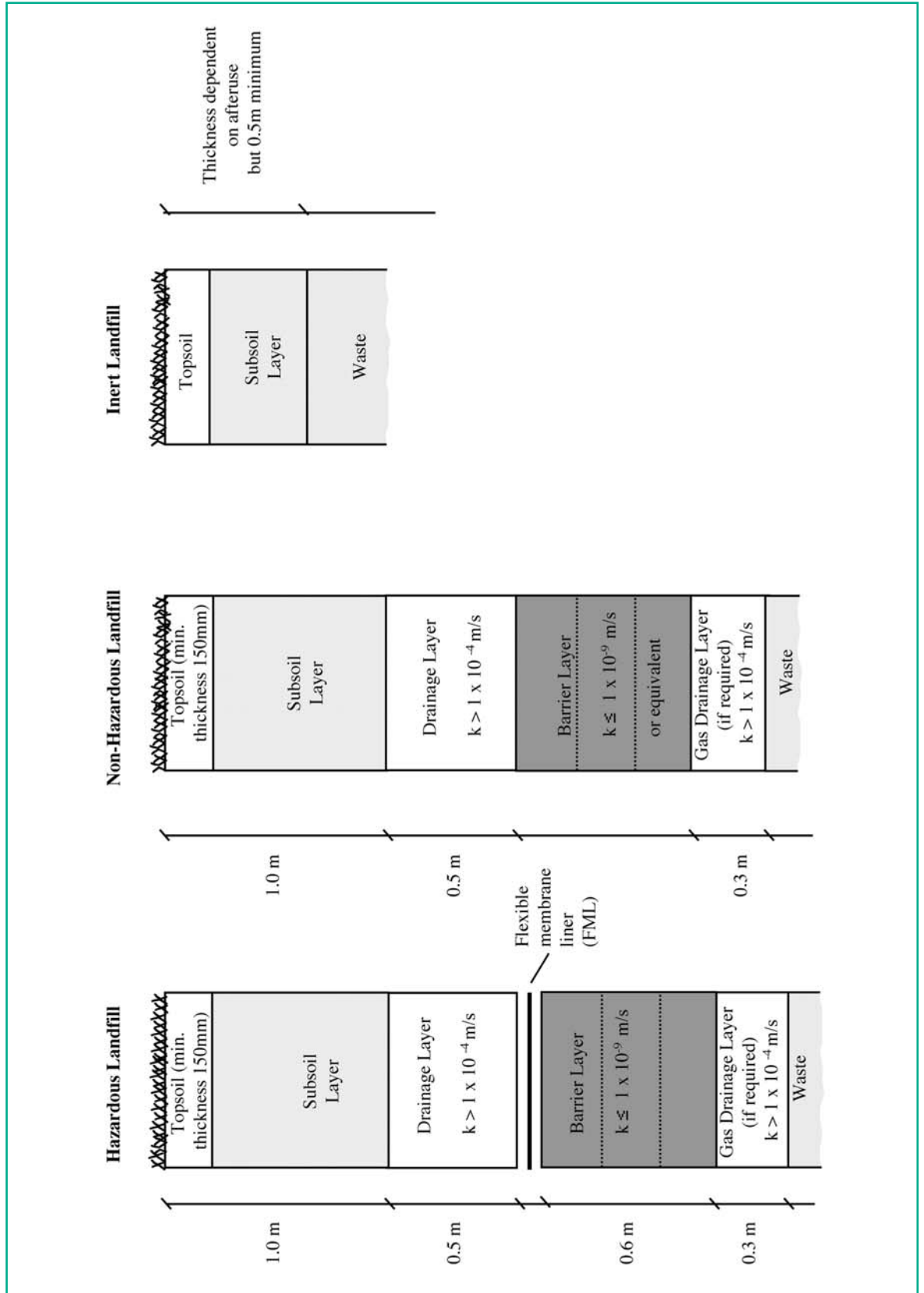

## 11. QUALITY ASSURANCE & QUALITY CONTROL

### 11.1 INTRODUCTION

For overall quality management it is essential that the landfill design includes a comprehensive construction quality assurance (CQA) plan with associated construction quality control (CQC) procedures to ensure materials and workmanship meet design specifications. Where geosynthetic materials (factory fabricated polymeric materials like geomembranes, geotextiles, geonets, geogrids, geosynthetic clay liners etc.) are used in the design they should be accompanied with the manufacturers manufacturing quality assurance (MQA) and manufacturing quality control (MQC) documentation of the product.

CQA/MQA should be applied to all aspects of new landfills, expansion of existing facilities, site remediation projects and final cover systems.

### 11.2 DEFINITIONS

To assist with clarification of the above terms they are defined as follows:

**Construction Quality Control:** A planned system of inspection that is used to monitor and control the quality of a construction project. This assists the contractor to conform with project plans and specifications.

**Construction Quality Assurance:** A planned system of activities that provide assurance that the facility was constructed in accordance with the contract and technical specifications.

**Manufacturing Quality Control:** A planned system of inspection that is used to monitor and control the manufacture of a material which is factory originated.

**Manufacturers Quality Assurance:** A planned system of activities that provides assurance that the materials were manufactured as specified in the contract documents.

### 11.3 QUALITY ASSURANCE/QUALITY CONTROL PLAN

The Quality Assurance (QA) plan includes plans for both the CQA and the MQA. It is developed in advance of any implementation of these activities.

The CQA/CQC plans are implemented through inspection activities that include visual observations, field testing and measurements, laboratory testing, and evaluation of the test data.

The CQA programme relies on the technical specification and the conditions of contract drawn up by the designer. These should include minimum (or maximum) requirements for materials and tests to be undertaken to verify the materials and/or the construction are meeting the specified standards.

#### 11.3.1 STRUCTURAL ORGANISATION OF A QA/QC PLAN AND STAFFING

In order for the quality assurance plan to run smoothly the organisational structure must be defined, a typical example is given in Figure 11.1. This flowchart outlines the process involved from when the licensing authority (EPA) is satisfied the applicant can commence the design, through to the stage where waste can be accepted at the facility. Intervening steps include the quality engineer(s) undertaking the tasks in the QA plan to verify that the contractor(s) construction quality control meets the specified standards.

The QA plan sets out in detail the activities and responsibilities of the Quality Engineer and should give full details, including responsibilities, of all the staff involved in the construction of the landfill. Table 11.1 gives typical details of the main responsibilities of the parties involved in the design and construction of a landfill site. Construction quality assurance should be undertaken by an independent third party on behalf of the owner/operator.

FIGURE 11.1: QUALITY CONTROL/ASSURANCE

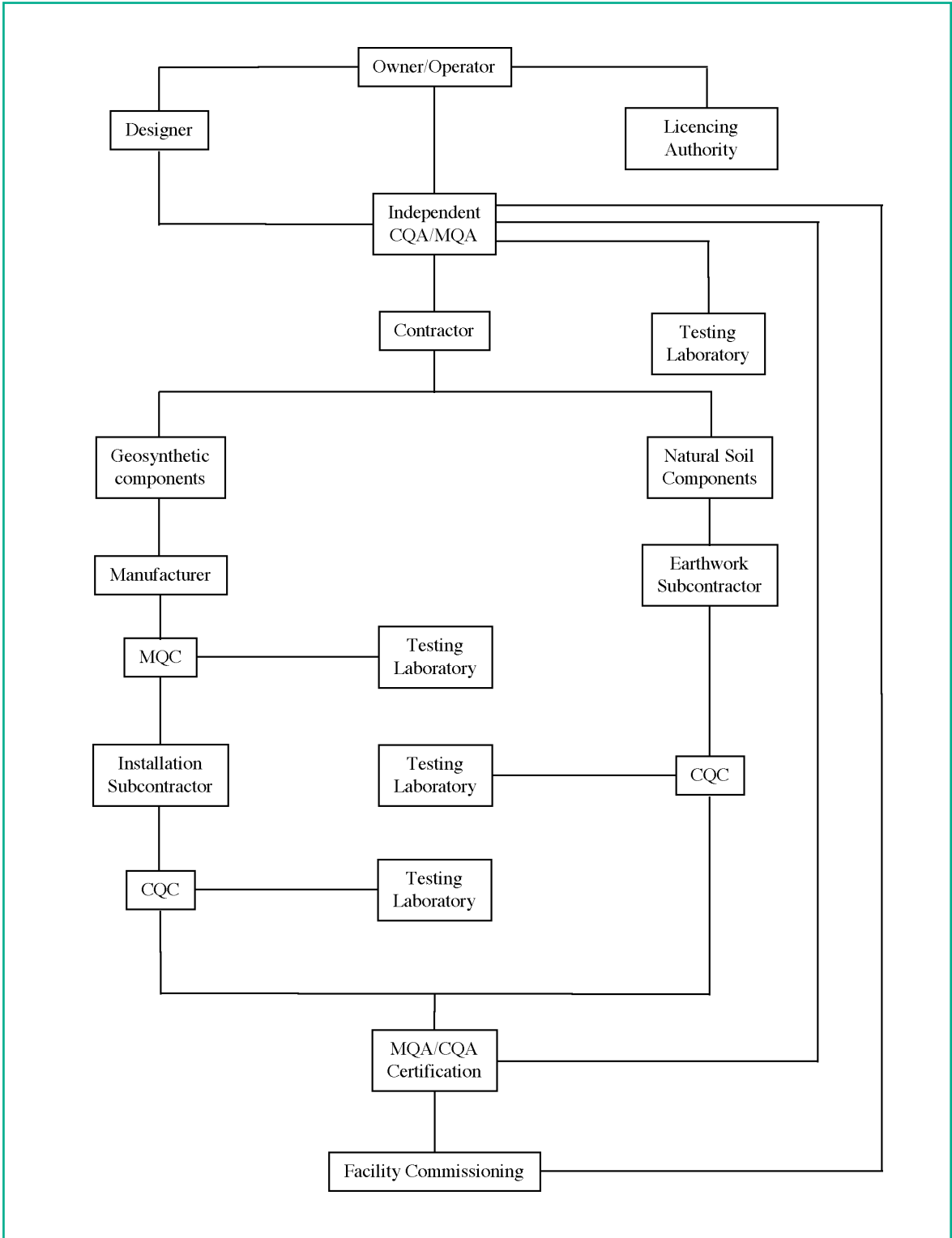

TABLE 11.1: RESPONSIBILITIES OF THOSE INVOLVED IN DEVELOPMENT OF A LANDFILL

| Personnel        | Responsibility  | Comment   |
|------------------|---|---|
| Owner/Operator   | Sponsors the design and construction of the facility  | Local Authority or private organisation   |
| Designer         | Design of the landfill to an acceptable standard which protects the surrounding environment.                  | In house design or design by consulting engineers. In either case the design team should have adequate experience of landfill design. |
| Contractor(s)    | To construct the work to the specification. Includes the liner manufacturer from fabrication to installation. | Contractors should be a reputable firm(s) with experience of similar works.   |
| Project Manager  | Management and supervision of the works.  | Can be the resident engineer or the quality engineer (see below) appointed by the owner/operator or the consultants.                  |
| Quality Engineer | Independent certification of the quality assurance.   | Employed by the owner/operator of the facility or the consultants but should be independent of the contractor.                        |

### 11.3.2 LICENSING AUTHORITY

The licensing authority may review QA documentation prior, during and after construction of a facility, including where necessary, visits to the manufacturing facility and construction site to observe the QA practices. The QA plan should be submitted to the licensing authority as part of the waste licence application.

### 11.3.3 COMPONENTS OF A QA/QC PLAN

The quality control plan should document the materials, test methods and the standards to be used and the number of tests to be performed.

The quality assurance documentation should at a minimum include the following:

- Details of proposed methods and standards of inspection and testing.
- Daily reports by the engineer in charge of the quality assurance containing:
  - date;
  - location of work on that particular day;
  - phase and cell(s) under construction;
- personnel involved;
- weather conditions;
- equipment being utilised;
- description of off-site material received including any quality control documentation; and
- decisions regarding approval of work or materials and/or corrective actions taken.
- A record of all quality meetings should be included in the QA plan. This should include pre construction meetings to ensure all parties are familiar with CQA, CQC procedures.
- Inspection and test reports (including field and laboratory testing), including:
  - description of the inspection activity or location from where the sample was obtained;
  - inspection observations and standards used;
  - recorded observation or test data; and
  - results of inspection activity and comparison with specification requirements.



- Problem identification and corrective measures including:
  - location and description of problem;
  - cause of problem;
  - suggest corrective measure; and
  - corrective measure taken.
- As constructed drawings. In advance of commissioning of the landfill the quality engineer should ensure that there is a complete set of as constructed drawings. Drawings of the lining system should include location of all panels, seams, samples, defects and repairs undertaken.
- Validation report. The product of a CQA system is a comprehensive report which demonstrates that the liner system, and associated components comply with the specification.

#### **11.4 COMMISSIONING**

When the validation report demonstrates that the landfill has been constructed to the specification and the facility has been approved by the licensing authority for the acceptance of waste it can commence operation.

## 12. HEALTH AND SAFETY

### 12.1 INTRODUCTION

The landfill designer should be aware of and ensure compliance with current legislation. Health and Safety Regulation requirements need to be addressed over the entire lifespan of the landfill development. These will effect the operator and employees of the facility, designers, contractors and their respective site staff. The Agency's Manual on '*Landfill Operational Practices*' provides general guidance on good landfill practices.

#### Irish Legislation

- Safety, Health and Welfare at Work Act, 1989;
- Safety, Health and Welfare at Work Regulations (SI 44 of 1993); and
- Safety, Health and Welfare at Work (Construction Sites) Regulations (SI 138 of 1995).

#### EU Legislation

- Framework Directive 89/39/EEC - Improvement of Health and Safety of Workers; and
- Directive 92/57/EEC - Safety on Building Sites.

The organisation with responsibility for administering and enforcing the provisions of the 1989 Act are the Health and Safety Authority. The advice of the Health and Safety Authority should be followed and nothing in this manual should be construed as advice to the contrary.

### 12.2 SAFETY, HEALTH AND WELFARE AT WORK ACT, 1989

This Act contains five principal elements:

- Duty of employers to ensure the safety, health and welfare of employees and other affected persons;
- Duty on employers to compile a safety statement;
- Rights of employees to be consulted on safety, health and welfare issues;
- Responsibility of employees to safeguard their own safety; and

- Establishment of Health and Safety Authority.

### 12.3 THE SAFETY, HEALTH AND WELFARE AT WORK (CONSTRUCTION SITES) REGULATIONS, 1995

The legislation most relevant to the designer is the Safety, Health and Welfare (Construction Sites) Regulations (SI 138 of 1995). These Regulations transpose into Irish law EU Directive 92/57/EEC on the implementation of minimum safety and health requirements at temporary or mobile construction sites. The purpose of the Regulations is to improve site safety.

The Regulations contain two sets of responsibilities:

- Sections 1-3: The duties of the clients, project supervisors, designers, contractors, self-employed persons, employees and other persons; and
- Sections 4-18: Specific requirements in relation to safety and health on building sites with particular reference to certain high risk activities.

The main requirements of the regulations are:

*Commencement Notices:* Inform the Health and Safety Authority and place site notice;

*Health and Safety Plan:* Required for all projects which require a commencement notice or involve a particular risk as set out in the second schedule to the regulations. The safety plan must be prepared prior to the start of the site works and is required to be updated as the works proceed; and

*Safety File:* This is the owners record of the site. It is developed as the sites works progress to completion. The safety file should be passed onto future owners of the site.

Table 12.1 provides a summary of the main duties of the various parties.

TABLE 12.1: HEALTH, SAFETY, AND WELFARE AT WORK (CONSTRUCTION REGULATIONS) 1995 SUMMARY OF MAIN DUTIES

| Activity               | Client  | Project Supervisor Design (PS(D))  | Project Supervisor Construction (PS(C))  | Designers   | Contractors  |
|------------------------|---|--|--|---|--|
| Appointments           | Duty: Appoint competent persons as PS(D) and PS(C) to all "projects"  | Advise clients on appointment of PS(C).<br>Check competence of contractor as PS(C)<br>Appoint Co-ordinator if required.<br>Check insurances. | Appoint Co-ordinator if required.<br>Check insurances of Sub-Contractors.  |   |  |
| Design                 |   | Duty: Take account of the Safety File if it exists.<br>Co-ordinate the input of those involved in the design.                                |  | Duty: Take account of Safety File and general principles of prevention. |  |
| Commencement Notice    |   | Assess if the project will require > 500 man-days or last more than 30 days or if it has "Particular Risks".                                 | Duty: Issue Notice of Commencement; keep copy on site.   |   |  |
| Health and Safety Plan |   | Duty: Prepare preliminary Safety Plan if required.<br>Provide preliminary plan to PS(C).   | Duty: Develop Safety Plan if it is required.<br>Revise the safety plan as works proceeds.  | Duty: Provide relevant information to PS(D) and PS(C).                  | Duty: Provide relevant information to PS(D) and PS(C).   |
| Construction Stage     |   |  | Duty: Co-ordinate implementation of the Safety Plan where there is more than one contractor.<br>Keep records.<br>Control access to site. |   | Duty: Comply with Regulations (Part 4-18).<br>Apply general principles of prevention.<br>Follow directions of PS(C).<br>Provide relevant information to PS(C). |
| Safety File            | Duty: Keep Safety File for future reference.<br>Pass to purchaser or tenant if selling or leasing the building. | Duty: Provide any available relevant information to PS(C).<br>Require other designers to do likewise.  | Duty: Prepare the Safety File.<br>Pass it on to the Client on completion of the works.   | Duty: Provide relevant information to PS(C).                            | Duty: Provide relevant information to PS(C).   |

Source: Institute of Engineers of Ireland (1996)



## GLOSSARY

**Absorptive capacity:** maximum amount of liquid taken up and retained by unit weight of solid under specified conditions; usually the amount of liquid retained by unit weight of waste in a landfill before leachate is produced.

**Acetogenic stage:** initial period during anaerobic decomposition of waste in a landfill, when the conversion of organic polymers, such as cellulose, to simple compounds such as acetic and other short chain fatty acids dominate and little or no methanogenic activity takes place.

**Activated sludge:** a flocculant microbial mass of bacteria, protozoa and other micro-organisms with a significant proportion of inert debris, produced when sewage is continuously aerated.

**Advanced treatment:** additional treatment processes which result in further purification than that obtained by applying primary and secondary treatment.

**Aerobic:** a condition in which elementary oxygen is available and utilised in the free form by bacteria.

**Aftercare:** any measures that are necessary to be taken in relation to the facility for the purposes of preventing environmental pollution following the cessation of the activity in question at a facility.

**Afteruse:** the use to which a landfill is put following restoration.

**Anaerobic:** a condition in which oxygen is not available in the form of dissolved oxygen or nitrate/nitrite.

**Anchor trench:** a trench where the ends of geosynthetic materials are embedded and suitably backfilled.

**Aquifer:** soil or rock forming a stratum, group of strata or part of a stratum that is water bearing.

**Attenuation:** the decrease in concentration of chemical species present in a liquid, caused by any of a variety of mechanisms, individually or in combination, including dilution, adsorption, precipitation, ion-exchange, biodegradation, oxidation, reduction, etc..

**Atterberg Limits:** liquid limit and plastic limit of a soil.

**Baseline monitoring:** monitoring in and around the location of a proposed facility so as to establish background environmental conditions prior to any development of the proposed facility.

**BATNEEC:** Best Available Technology Not Entailing Excessive Cost as defined in section 5 (2) of the WMA.

**Bentonite:** any commercially processed clay material consisting primarily of the mineral group smectite.

**Biochemical oxygen demand (BOD):** is a measure of the rate at which micro-organisms use dissolved oxygen in the bacterial breakdown of organic matter (food) under aerobic conditions. The BOD<sub>5</sub> test indicates the organic strength of a waste water and is determined by measuring the dissolved oxygen concentration before and after the incubation of a sample at 20°C for five days in the dark. An inhibitor may be added to prevent nitrification from occurring.

**Biodegradable waste:** any waste that is capable of undergoing anaerobic or aerobic decomposition, such as food and garden waste, and paper and paperboard.

**Biofouling:** clogging of wells, pumps or pipework as a result of bacterial growth.

**Borehole:** a shaft installed outside waste area for the monitoring of and/or the extraction of LFG/groundwater. Established by placing a casing and well screen into the boring. If installed within the waste area it is called a well.

**Borrow pit:** an area where material is taken from to use elsewhere.

**Bunding/berm:** a dike or mound usually of clay or other inert material used to define limits of cells or phase or roadways; or to screen the operation of a landfill from adjacent properties; reducing noise, visibility, dust, and litter impacts.

**Capping system:** system comprising of a number of different components placed over the waste principally to minimise infiltration into the waste.

**Capping:** the covering of a landfill, usually with low permeability material (Landfill cap).

**Cells:** subdivision of phases.

**Centrifugal gas booster:** a gas booster which uses a rotating impeller in a specially shaped casing to convert the kinetic energy of a gas flow into pressure rise.

**Chemical oxygen demand (COD):** is a measure of the amount of oxygen consumed from a chemical oxidising agent under controlled conditions. The COD is generally greater than the BOD as the chemical agent will often oxidise more compounds than is possible under biological conditions.

**Civic waste facility:** is a facility used to provide householders and commercial operators with a convenient centre to drop off recyclables and other wastes.

**Coagulants:** chemicals that destabilise colloids and cause the fine colloidal particles to clump together (flocculate) into larger particles, which can be separated from the water by settlement or flotation.

**Colloid:** very small, finely divided solids (particles that do not dissolve and cannot be removed by filtering) that remain dispersed in a liquid for a long time due to their small size and electrical charge. When most of the particles in water have a negative electrical charge, they tend to repel each other. This repulsion prevents the particles from becoming heavier and settling out.

**Composite liner:** comprises two or more liners in direct contact with each other.

**Compost:** organic matter decomposed aerobically and used as a fertiliser or soil conditioner.

**Condensate:** the liquid which forms within gas pipework due to the condensation of water vapour from LFG.

**Confined aquifer:** an aquifer in which the water is confined under pressure by overlying and underlying impermeable strata.

**Construction / demolition waste:** masonry and rubble wastes arising from the demolition or construction of buildings or other civil engineering structures.

**Construction Quality Assurance (CQA):** A planned system of activities that provide assurance that the facility was constructed in accordance with the contract and technical specifications.

**Construction Quality Control (CQC):** A planned system of inspection that is used to monitor and control the quality of a construction project. This assists the contractor to conform with project plans and specifications.

**Contour:** a line on a topographic map that connects points with the same elevation; or a line on a plan view that identifies common groundwater elevations or equal concentrations of pollutants in the groundwater (contamination plume).

**Convection:** movement of gas from areas of high pressure to areas of low pressure.

**Cores:** material obtained when using a hollow drill to produce a borehole.

**Daily cover:** is the term used to describe material spread (about 150mm if soil cover used) over deposited waste at the end of every working day.

**Denitrification:** the reduction of nitrate to molecular nitrogen ( $N_2$ ) under anoxic conditions. The nitrate is used as an oxygen source by heterotrophic bacteria in the absence of molecular oxygen. A source of carbon must be added.

**Density:** the mass per unit volume of a substance.

**Destructive tests:** are tests performed on geomembrane seam samples cut out of a field installation or test strip to verify specification performance requirements.

**Dewatering:** a means of groundwater control.

**Diffusion:** from an area of high concentration to an area of low concentration.

**Direct discharge:** introduction into groundwater of substances in Lists I or II without percolation through the ground or subsoil.

**Downgradient:** the direction towards which groundwater or surface water flows. Also referred to as downslope.

**Effective rainfall:** total rainfall minus actual losses due to evaporation and transpiration.

**Effluent:** a liquid which flows from a process or system.

**Elevated flare:** these burn LFG as open flames.

**Emission:** meaning assigned by the EPA Act of 1992.

**Flame arrestor:** in the case of landfill gas catching fire in the pipes or process equipment or a flame entering the pipe from a burner, the flame arrestor prevents the fire or flame moving back down the pipe.

**Flare unit:** a device used for the combustion of landfill gas thereby converting its methane content to carbon dioxide.

**Flocculation:** is the practice of gently stirring water in which a floc has formed to induce the particles to coalesce and grow and thus settle more rapidly.

**Flexible membrane liner (FML)/Geomembrane:** an essentially impermeable membrane used with foundation, soil, rock, earth, or any other geotechnical engineering related material as an integral part of human made project, structure or system.

**Formation level:** the final dig level of an excavation.

**Freeboard:** the distance from the water line on the structure to the top of the structure. In the case of a surface impoundment it is the distance between the maximum operating level and the liquid level which would result in the release of stored liquid.



**Gas wells:** wells installed during filling or retrofitted later within the waste area for the monitoring of and/or removal of landfill gas either actively through an extraction system or passively by venting.

**Geocomposite:** a manufactured material using geotextiles, geogrids, geonets, and/or geomembranes in laminated or composite form.

**Geogrid:** a geosynthetic used for reinforcement.

**Geonet:** a geosynthetic for drainage of liquids and gases.

**Geosynthetic Clay Liners (GCL's):** factory manufactured, hydraulic barriers typically consisting of bentonite clay or other very low permeability materials (poder or granulated bentonite with or without an adhesive mixed into the bentonite), supported by geotextiles and/or geomembranes which are held together by needling, stitching or chemical adhesives.

**Geosynthetics:** generic term for all synthetic materials used in geotechnical engineering applications; the term includes geomembranes, geotextiles, geonet, geogrids, geosynthetic clay liners, and geocomposites, etc..

**Geotextile:** any permeable textile used with foundation, soil, rock, earth, or any other geotechnical engineering related material as an integral part of a human made project, structure or system.

**Greenhouse effect:** the accumulation of gases in the upper atmosphere which absorb heat re-radiated from the earth's surface, resulting in increase in global temperature.

**Groundwater:** water which is below the surface of the ground in the saturation zone and in direct contact with the ground or subsoil.

**Hazardous landfill:** landfill that accepts only hazardous waste that fulfils the criteria set out in the Agency's manual 'Waste Acceptance' and that set out in Article 6 of '*Council Directive 1999/31/EC on the landfill of waste*'.

**Hydraulic conductivity (K):** coefficient of proportionality that describes the rate at which a fluid can move through a permeable medium. It is a function of both the media (solid component) and the fluid flowing through it (also known as coefficient of permeability).

**Hydraulic gradient:** The change in total hydraulic head between two points, divided by the length of flow paths between the points.

**Hydraulic load:** the volumetric flow in relation to the hydraulic capacity of the collecting system or treatment plant.

**Hydrogeology:** study of the interrelationships of the geology of soils and rock with groundwater.

**Hydrolysis:** large organic molecules are split by bacteria into small soluble molecules, e.g. lower fatty acids, simple sugars and amino acids.

**Indirect discharge:** introduction into groundwater of substances in Lists I or II after percolation through the ground or subsoil.

**Inert landfill:** landfill that accepts only inert waste that fulfils the criteria set out in the Agency's manual 'Waste Acceptance'.

**Intermediate cover:** refers to placement of material (minimum 300mm if soil used) for a period of time prior to restoration or prior to further disposal of waste.

**Lagoon:** land area used to contain liquid, e.g. leachate collected from landfill.

**Landfill Gas (LFG):** all gases generated from the landfilled waste.

**Landfill:** waste disposal facility used for the deposit of waste on to or into land.

**Leachate collection and removal system (LCRS):** engineered system to draw leachate to a central point for removal, with the purpose of minimising the accumulation and depth of leachate on the liner.

**Leachate recirculation:** practice of returning leachate to a landfill from which it has been abstracted.

**Leachate well:** well installed within the waste area for the monitoring and/or extraction of leachate ... as opposed to borehole which is the term used when located outside of the waste deposition area.

**Leachate:** any liquid percolating through the deposited waste and emitted from or contained within a landfill as defined in Section 5 (1) of the WMA.

**Liner system:** combination of drainage layers and liners.

**Liner:** a low permeability barrier installed to impede the flow of leachate, groundwater and landfill gas.

**Liquid Waste:** any waste in liquid form (including waste waters but excluding sludge) and containing less than 2% dry matter.

**List I/II substances:** substances referred to in the EU Directives on Dangerous Substances (76/464/EEC) and Groundwater (80/68/EC).

**Lower explosive limit (LEL):** the lowest percentage concentration by volume of a mixture of flammable gas with air which will propagate a flame at 25°C and atmospheric pressure.

**Manufacturers Quality Assurance (MQA):** A planned system of activities that provides assurance that the materials were manufactured as specified in the contract documents.

**Manufacturing Quality Control (MQC):** A planned system of inspection that is used to monitor and control the manufacture of a material which is factory originated.

**Methanogenic stage:** phase where fatty acids are degraded to methane and carbon dioxide by bacteria.

**Moisture content:** weight of moisture (usually water) contained in a sample of waste or soil. Usually determined by drying the sample at 105°C to constant weight.

**Nitrification:** the sequential oxidation of ammonia and ammonium firstly to nitrite and then to nitrate by the autotrophic bacteria *Nitrosomas* and *Nitrobacter*.

**Non destructive test:** an in situ test that does not require the removal of samples from, nor damage to, the installed liner system.

**Non-hazardous landfill:** landfill that accepts waste that fulfils the criteria set out in the Agency's manual 'Waste Acceptance' and that set out in Article 6 of 'Council Directive 1999/31/EC on the landfill of waste'.

**Organic load:** the mass of organic polluting matter discharging from a sewer expressed as kg organic matter per m<sup>3</sup> of flow.

**Phasing:** progressive use of the landfill area so that construction, operation (filling) and restoration can occur simultaneously in different parts of the site.

**Piezometric level:** the level representing the total hydraulic head of groundwater in a confined aquifer.

**Pore water pressure:** pressure of groundwater in a soil, measured relative to atmospheric pressure.

**Receiving water:** a body of water, flowing or otherwise, such as a stream, river, lake, estuary or sea, into which water or wastewater is discharged.

**Restoration:** works carried out on a landfill site to allow planned afteruse.

**Rotating biological contactor:** an attached growth biofilm process using rotating support media.

**Shrouded flare:** a flare where the combustion processes take place in a combustion chamber. The combustion chamber is thermally insulated to prevent the flame from cooling. Some means of combustion control is normally provided. Also known as a closed flare or ground flare.

**Sludge:** the accumulation of solids resulting from chemical coagulation, flocculation and/or sedimentation after water or wastewater treatment with between 2% and 14% dry matter.

**Specific permeability (k):** measure of the rate at which a fluid will pass through a medium. A property of the medium only (solid component).

**Stripping:** removal of volatile components from liquid by gas exchange.

**Total hydraulic head:** the height, measured relative to an arbitrary datum level, to which water will rise in a piezometer. The total hydraulic head at a given point in an aquifer is the sum of the elevation head (height of the point above the datum) and the pressure head (height of the water above the point recorded in a standpipe piezometer).

**Total organic carbon (TOC):** mass concentration of carbon present in the organic matter which is dissolved or suspended in water.

**Transmissivity:** a measure of the ease with which water can flow through the saturated thickness of an aquifer: permeable geological stratum or formation that is capable of both storing and transmitting water in significant amounts.

**Trial pit:** an excavated pit.

**Trigger Level:** is a value which when encountered requires certain actions to be taken.

**Unconfined aquifer:** where the upper surface of a saturated zone forms a water table.

**Upper explosive limit (UEL):** the highest percentage concentration by volume of a mixture of flammable gas with air which will propagate a flame at 25°C and atmospheric pressure.

**Vent:** refers to system provided in a landfill to permit the escape to atmosphere of gases and vapours generated by deposited waste during biodegradation.

**Void space:** space available to deposit waste.

**Water balance:** a calculation to estimate a volume of liquid generated. In the case of landfills, water balance normally refers to leachate generation volumes.

**Water table:** the level in an unconfined aquifer at which the pore water pressure is zero (i.e. atmospheric).

**Well head:** fitting to the top of a gas well to control the extraction of landfill gas.

## REFERENCES AND FURTHER READING

1. Alther, G.R. (1983) 'The Methylene Blue Test for Bentonite Liner Quality Control' *Geotechnical Testing Journal*, Vol. 6, No.3, pp133-143.
2. American Society for Testing and Materials (1994) *ASTM Standards and Other Specifications and Test Methods on the Quality Assurance of Landfill Liner Systems*. ASTM, Philadelphia, PA.
3. Bell, A. L. (1993) *Grouting in the Ground*, Thomas Telford, London.
4. British Standards Institution (1986) BS 8004: *Code of Practice for Foundations*, BSI.
5. British Standards Institution (1987) BS8007: *Code of Practice for Design of Concrete Structures for Retaining Aqueous Liquids*, BSI.
6. British Standards Institution (1990) BS1377: *British Standard Methods of Tests for Soils for Civil Engineering Purposes*, BSI.
7. Christensen, T.H.; Cossu, R.; Stegmann, R. (Eds.) (1992) *Landfilling of Waste: Leachate*, Elsevier Applied Science.
8. CIRIA (1988) *Control of Groundwater for Temporary Works*. CIRIA (R113), London.
9. CIRIA (1993) *The Design and Construction of Sheet-Piled Cofferdams* Special Publication 95. CIRIA (SP95), London.
10. CIRIA (1993) *The Measurement of Methane and Other Gases from the Ground*. CIRIA (R131), London.
11. CIRIA (1996) *Barrier Liners and Cover Systems for Containment and Control of Land Contamination* Special Publication 124. CIRIA (SP124), London.
12. Commission of the European Communities (1996) 'Communication from the Commission on the Review of the Community Strategy for Waste Management Draft Council Resolution on Waste Policy', COM(96) 399.
13. Coomber, D.B. (1986) 'Groundwater Control by Jet Grouting', *Groundwater in Engineering Geology* (J. C. Cripps, F. G. Bell and M. G. Culshaw eds.), Geological Society Engineering Geology Special Publication No. 3, London pp. 445-454.
14. Council Directive (1980) on the Protection of Groundwater against Pollution caused by certain Dangerous Substances (80/68/EEC) (OJ L20 p43).
15. Council Directive (1999) on the Landfill of Waste, (99/31/EC) (OJ L182/4).
16. Daniel, D.E. (1989) 'In Situ Hydraulic Conductivity Tests for Compacted Clay', *Journal of Geotechnical Engineering*, Vol. 115, No.9, pp. 1205-1226.
17. Department of the Environment (1994) *Protection of New Buildings and Occupants from Landfill Gas*, Government Publications, Dublin.
18. Department of the Environment (1995) *Specifications for Roadworks*, Government Publications, Dublin.
19. Department of the Environment (1996) *Traffic Signs Manual*, Government Publications, Dublin.

20. Department of the Environment (1997) *Sustainable Development: A Strategy for Ireland*, Government Publications, Dublin.
21. Department of the Environment and Local Government (1998) *Waste Management - A Policy Statement -changing our ways*. Government Publications, Dublin.
22. Department of the Environment and Local Government / Environmental Protection Agency / Geological Survey of Ireland (1999) *Groundwater Protection Schemes*. Government Publications, Dublin.
23. Department of Trade and Industry (UK) (1995) *Technology status report 017*.
24. Environment Agency (UK) (1998) *A Methodology for Cylinder Testing of Protectors for Geomembranes* Environment Agency, Regional Waste Team, Warrington, UK.
25. Environmental Protection Agency (1995) *Landfill Manual: Investigations For Landfills*, EPA, Wexford.
26. Environmental Protection Agency (1995) *Landfill Manual: Landfill Monitoring*, EPA, Wexford.
27. Environmental Protection Agency (1995) *Water Treatment Manuals: Filtration*, EPA, Wexford.
28. Environmental Protection Agency (1996) *National Waste Database Report 1995*, EPA, Wexford.
29. Environmental Protection Agency (1997) *Landfill Manual: Landfill Operational Practices*, EPA, Wexford.
30. Environmental Protection Agency (1998) *Draft Landfill Manual: Waste Acceptance*, EPA, Wexford.
31. Environmental Protection Agency (1999) *Wastewater Treatment Manual 'Treatment Systems for Small Communities, Business, Leisure Centres and Hotels*, EPA, Wexford.
32. Environmental Protection Agency Act (1992) Government Publications, Dublin.
33. ETSU (1996) *Landfill Gas -Development Guidelines*, Oxfordshire, UK.
34. ETSU (1993) *Guidelines for the Safe Control and Utilisation of Landfill Gas Part 1 - Introduction* B/1296-P1, Oxfordshire, UK.
35. ETSU (1993) *Guidelines for the Safe Control and Utilisation of Landfill Gas Part 2 - Control and Instrumentation* B/1296-P2, Oxfordshire, UK.
36. ETSU (1993) *Guidelines for the Safe Control and Utilisation of Landfill Gas Part 3 - Environmental Impacts and Law* B/1296-P3, Oxfordshire, UK.
37. ETSU (1993) *Guidelines for the Safe Control and Utilisation of Landfill Gas Part 4A - A Brief Guide to Utilising Landfill Gas* B/1296-P4A, Oxfordshire, UK.
38. ETSU (1993) *Guidelines for the Safe Control and Utilisation of Landfill Gas Part 4B - Utilising Landfill Gas* B/1296-P4B, Oxfordshire, UK.
39. ETSU (1993) *Guidelines for the Safe Control and Utilisation of Landfill Gas Part 5 - Gas Wells* B/1296-P5, Oxfordshire, UK.
40. ETSU (1993) *Guidelines for the Safe Control and Utilisation of Landfill Gas Part 6 - Gas Handling and Associated Pipework* B/1296-P6, Oxfordshire, UK.
41. ETSU (1996) *A Review of the Direct Use of Landfill Gas - Best Practice Guidelines for the Use of Landfill Gas as a Source of Heat* B/LF/00474/REP/1, Oxfordshire, UK.

42. ETSU (1996) *A Technical Survey of Power Generation from Biogas* B/LG/00325/REP, Oxfordshire, UK.
43. EU Council Directive on Waste (75/442/EEC) (OJ L194 p39) as amended by Directives 91/156 (OJ L78 p32) and 91/692.
44. Fletcher, I. J. and Ashbee, E. (1994) 'Ammonia Stripping for Landfill Leachate Treatment - a Review', *Nutrient Removal from Wastewaters*. Horan, N. J. (Ed). Technomic, pp. 109-117.
45. National Environment Research Council (1975) *Flood Studies Report 5* Volumes, Wallingford, UK.
46. German Geotechnical Society for the International Society of Soil Mechanics and Foundation Engineering (1993) *Geotechnics of Landfill Design and Remedial Works Technical Recommendations* - GLR, Ernst, Berlin.
47. Giroud, J. P. and Bonaparte, R. (1989a) 'Leakage through Liners Constructed with Geomembranes, Part I: Geomembrane Liners', *Geotextiles and Geomembranes*, 8, 1: 27-67.
48. Giroud, J. P., Badu-Tweneboah, K., and Soderman, K.L.(1994) 'Evaluation of Landfill Liners' Fifth *International Conference on Geotextiles, Geomembranes and Related Products*, Singapore, 5-9 September 1994.
49. Giroud, J. P., Khatami, A. and Badu-Tweneboah, K (1989) Evaluation of the Rate of Leakage through Composite Liners, *Geotextiles and Geomembranes*, 8, 4: 337-340.
50. Gregory, R. G., Manley, B. J. W. and Garner, N. (1991) *Evaluation of National Assessment of Landfill Gas Production*. ETSU Contractors Report. ETSU, Oxfordshire, UK.
51. Grontmij (1997) Communication with EPA.
52. Harris, J. M. 'Landfill Leachate Recirculation from an Owner/Operator's Perspective' *Seminar publication - Landfill Bioreactor Design and Operation*. EPA/600/R/146. U.S. EPA; National Risk Management Research Laboratory; Office of Research and Development; Cincinnati, Ohio, 45268. pp.185-191.
53. Harris, J. S. (1995) *Ground Freeze in Practice*, Thomas Telford, London.
54. Head, K.H. (1981) 'Permeability, Shear Strength and Compressibility Tests' *Manual of Soil Laboratory Testing, Volume 2*. Pentech Press, London.
55. Head, K.H. (1986) 'Effective Stress Tests' *Manual of Soil Laboratory Testing, Volume 3*. Pentech Press, London.
56. Health Safety and Welfare at Work Act 1989. Government Publications, Dublin.
57. Hjelmar, O., Johannessen, L.M., Knox, K., Ehrig, H.J., Flyvbjerg, J., Winther, P. and Christensen, T.H. (1994) *Management And Composition Of Leachate From Landfills*. Final Report to the Commission of the European Communities. DGXI A.4, Waste '92, Contract No.:B4-3040/013665/92.
58. Hjelmar, O., Johannessen, L.M., Knox, K., Ehrig, H.J., Flyvbjerg, J., Winther, P. And Christensen, T.H. (1995) 'Composition and Management of Leachate from Landfills within the EU' *Proceedings Sardinia 95, Fifth International Landfill Symposium*, S. Margherita di Pula, Cagliari, Italy. pp 243-262.
59. Institute of Engineers of Ireland (1996) *Health, Safety & Welfare at Work (Construction) Regulations 1995, Advice for Engineers acting as Project Supervisor for Design Stage*. IEI, Dublin.
60. Jardine, F. M. and McCallum, R. I. (1994) *Engineering and Health in Compressed Air Work*, Spon, London.



61. Jefferis, S. A. (1993) 'In Ground Barriers' in *Contaminated Land - Problems and Solutions*, (T Cairney, ed.), Blackie, London, pp. 111-140.
62. Jesionek, K.S., Dunn, R.J., and Daniel, D.E. (1995) 'Evaluation of Landfill Final Covers' *Proceedings Sardinia 95, Fifth International Landfill Symposium*, S. Margherita di Pula, Cagliari, Italy; 2-6 October 1995. CISA, Environmental Sanitary Engineering Centre, Cagliari, Italy.
63. Jessberger, H. L. (1994) 'Geotechnical Aspects of Landfill Design and Construction', *Proc. Instn Civ Engrs Geotech Engng*, Apr 107.
64. Knox, K. (1991) *A Review of Water Balance Methods and Their Application to Landfill in the U.K.* Department of the Environment U.K. Wastes Technical Division, Research Report No. CWM--031-91.
65. Koerner, R. and D. Daniel, (1997) *Final Covers for Solid Waste Landfills and Abandoned Dumps*. Thomas Telford, London.
66. Leach, A. (1991) 'A Practical Study of the Performance of Various Gas Cell Designs and of Combined Gas and Leachate Abstraction Systems', *Proceedings Sardinia 91, Third International Landfill Symposium*, S. Margherita di Pula, Cagliari, Italy; 14-18 October 1991. CISA, Environmental Sanitary Engineering Centre, Cagliari, Italy.
67. Logue J. J., (1975) *Extreme Rainfall in Ireland*, Technical Note No 40 Meteorological Service.
68. MET ÉIREANN (1997) Communications between the EPA and The Irish Meteorological Service.
69. Miller, W.L., Earle, J. F. K., and D. Reinhart. (1994) *Leachate Recycle and the Augmentation of Biological Decomposition at Municipal Solid Waste Landfills*. Annual report to Florida Center for solid and Hazardous Waste Management (June 1).
70. Miller, D.E.; Ball, B.R. (1994) 'Leachate Recirculation System Design and Operation at a Western Landfill' *Proc. 17th International Madison Waste Conf., Municipal and Industrial Waste*, Madison, WI, USA, 21-22 Sep. 1994. University of Wisconsin-Madison, pp. 530-547.
71. Mitchell, J.K., Hooper, D.R., and Campanella, R.G. (1965) 'Permeability of Compacted Clay' *Journal of the Soil Mechanics and Foundations Division*, ASCE, Vol.91, No. SM4, pp. 41-65.
72. Murray, E.J. (1998) 'Properties and Testing of Clay Liners' in *Geotechnical Engineering of Landfills* (ed. Dixon, N., E. J. Murray and D. R. V. Jones *Proceedings of the Symposium held at The Nottingham Trent University*, pp. 37-60. Thomas Telford, London.
73. National Association of Waste Disposal Contractors (NAWDC) (1992) *Guidelines for Landfill; Guideline for Leachate Treatment*. NAWDC Publications, London, UK.
74. National Roads Authority (2000) *Manual of Contract Documents for Roadworks*, NRA, Dublin.
75. North West Regulation Officers Technical Subgroup (1996) *Earthworks on Landfill Sites: A Technical Note on the Design, Construction and Quality Assurance of Compacted Clay Liners*. Cheshire Waste Regulation Authority, UK.
76. North West Waste Disposal Officers (1991) *Leachate Management Report*, November, 1991. Cheshire Waste Regulation Authority, UK
77. NSF 54 (1993) *Flexible Membrane Liners*. NSF International, Ann Arbor, Michigan, USA.
78. Puller, M. (1996) *Deep Excavations - a Practical Manual*, Thomas Telford, London.



79. Qasim, S.R. and Chiang, W. (Eds.) (1994) *Sanitary Landfill Leachate: Generation, Control and Treatment*. Technomic Publishing Company Inc. Pennsylvania, 17604, USA.
80. Robinson, H. D., Formby, B.W., Barr, M.J., and M.S. Carville (1991) 'The Treatment of Landfill Leachate to Standards Suitable for Surface Water Discharge' *Proceedings Sardinia 91, Third International Landfill Symposium*, S. Margherita di Pula, Cagliari, Italy. pp. 905-918.
81. Site Investigation In Construction Part 4 (1993) - *Guidelines for safe investigation by drilling of landfills and contaminated land*, Thomas Telford, London.
82. *The Monitoring of Landfill Gas* (1998) Institute of Waste Management, Northampton, UK.
83. Townsend, T.G., Miller, W.L., Bishop, R.A., Carter, J.H. (1994) Combining Systems for Leachate Recirculation and Landfill Gas Collection. *Solid Waste Technol.*, Vol. 8, No. 4, (Jul.-Aug. 1994).
84. Department of the Environment (UK) (1991) *Waste Management Paper No 27 Landfill Gas*, HMSO, London.
85. Department of the Environment (UK) (1995) *Waste Management Paper 26B, Landfill Design, Construction and Operational Practice*, HMSO, London.
86. Department of the Environment (UK) (1995b) *The Technical Aspects of Controlled Waste Management - A Review of the Composition of Leachates from Domestic Wastes in Landfill Sites*, Waste Technical Division, Department of the Environment, London.
87. US Environmental Protection Agency (1989) Seminar Publication - *Requirements for Hazardous Landfill Design, Construction and Closure*. EPA/625/4-89/022. U.S. EPA; Centre for Environmental Research Information; Office of Research and Development; Cincinnati, Ohio, 45268.
88. US Environmental Protection Agency (1991) *Landfill Leachate Clogging of Geotextiles (and Soil) Filters*. EPA/600/2-91/025, August 1991, Risk Reduction Engineering Laboratory, Cincinnati, Ohio, 45268, NTIS PB-91-213660.
89. US Environmental Protection Agency (1991) *Technical Resource Document, Design, Construction, and Operation of Hazardous and Non-Hazardous Waste Surface Impoundments* EPA/530/SW-91/054 Washington, DC, USA.
90. US Environmental Protection Agency (1993) *Technical Guidance Document, Quality Assurance and Quality Control for Waste Containment Facilities*. EPA/600/R-93/182., Risk Reduction Engineering Laboratory, Office of Research and Development; U.S. EPA, Cincinnati, Ohio, 45268.
91. US Environmental Protection Agency (1993) *Technical Manual, Solid Waste Disposal Facility Criteria*. EPA/530/R-93/017., Risk Reduction Engineering Laboratory, Office of Research and Development; U.S. EPA, Cincinnati, Ohio, 45268.
92. US Environmental Protection Agency (1994) *Review of Liner and Cap Regulations for Landfills*. EPA/600/A-94/246., Risk Reduction Engineering Laboratory, Office of Research and Development, U.S. EPA, Cincinnati, Ohio, 45268.
93. US Environmental Protection Agency (1995) *Groundwater and Leachate Treatment Systems*. EPA/625/R-94/005. U.S. EPA, Centre for Environmental Research Information, Office of Research and Development; Cincinnati, Ohio, 45268.
94. Waste Management (Licensing) Regulations (1997) Government Publications, Dublin.
95. Waste Management Act (1996) Government Publications, Dublin.

96. Weber, B and Holz, F. (1991) 'Disposal of Leachate Treatment Residues' *Proceedings Sardinia 1991, Third International Landfill Symposium*; 14-18 October 1991.
97. Weston - FTA Ltd., 1993, *Strategy Study on Options for the Treatment and Disposal of Sewage Sludge in Ireland*, Department of the Environment, Dublin.

**Appendix A:  
STORAGE BUNDS**

## A.1 BUND TESTING

This section gives general guidance on Agency requirements in relation to drum storage area bunds. The guidance is divided into two sections, one dealing with bund construction and the other with bund testing. Industry is advised to contact the Agency should questions arise.

### Construction of Bunds

- bunds should be designed by a chartered civil or structural engineer.
- bunds should be designed in accordance with BS 8007 : 1987 Code of Practice for Design of Concrete Structures for Retaining Aqueous Liquids.
- requirements of the Health and Safety Authority and any relevant standards should be adhered to.
- bund design should take into account the capture of spigot flow from ruptured tanks.
- bulk chemical storage bunds should be designed to contain 110% of the capacity of the largest storage vessel located within the bund.
- drum storage areas should be designed to contain 110% of the capacity of the largest ten drums located within the bund and/or 25% of the volume of the material stored therein.
- only compatible chemicals should be stored in the same bund.
- individual bunding is preferred to common bunding.
- bund walls should not be constructed of brick or blockwork.
- if degradation of the bund wall or floor is likely due to contact with spillage then a protective lining should be incorporated on the bund's surface.
- valved drainage from bunds should be avoided.
- a means of removing surface water from the bund should be available (if the bund is not covered).

### Testing of Existing Bunds

- testing should be supervised and validated by a suitably competent person e.g. a chartered civil or structural engineer.
- where practical, bunds should be tested to BS 8007.
- special attention should be given to bund walls made of brick or blockwork which are greater than 600 mm in height. Strengthening of such structures may be required.
- a programme should be put in place to ensure that all bunds are tested at least once every three years.

**Appendix B:**  
**GROUNDWATER/SURFACE WATER MANAGEMENT**

## B.1 GROUNDWATER CONTROL METHODS

TABLE B.1: PHYSICAL CUT-OFF TECHNIQUES FOR EXCLUSION OF GROUNDWATER

| Method  | Typical Application  | Comments   |
|---|--|--|
| <b>Displacement barriers</b>                                    |  |  |
| Steel sheet piling  | Open excavations in most soils, but obstructions such as boulders may impede installation                                    | Temporary or long term. Can support the sides of the excavation with suitable propping. Vibration and noise of driving may be unacceptable on some sites, but 'silent' methods are available. See CIRIA SP95 (1993) and Section 5 of BS 8004:1986                                |
| Vibrated beam wall  | Open excavations in silts and sands.<br>Will not support the soil.   | A vibrating H-pile is driven into the ground and then removed. As it is removed, grout is injected through nozzles at the toe of the pile to form a thin, low permeability membrane. See CIRIA SP124 (1996)  |
| <b>Excavated barriers</b>                                       |  |  |
| Slurry trench cut-off with bentonite or native clay             | Open excavations in silts, sands and gravels up to a permeability of about $5 \times 10^{-3} \text{m/s}$                     | The slurry trench forms a low permeability curtain wall around the excavation. Quickly installed and relatively cheap, but costs increase rapidly with depth. See Jefferis (1993)  |
| Structural concrete diaphragm walls                             | Side walls of excavations and shafts in most soils and weak rocks  | Support the sides of the excavation and often form the sidewalls of the finished construction. Minimum noise and vibration. See Puller (1996)  |
| Secant (interlocking) and contiguous bored piles                | As diaphragm walls   | As diaphragm walls, but more likely to be economic for temporary works use. Sealing between contiguous piles can be difficult. See Puller (1996)   |
| <b>Injection barriers</b>                                       |  |  |
| Jet grouting  | Open excavations in most soils and very weak rocks   | Typically forms a series of overlapping columns of soil-grout mixture. See Coomber (1986)  |
| Injection grouting using cementitious grouts                    | Tunnels and shafts in gravels and coarse sands, and fissured rocks   | The grout fills the pore spaces, preventing the flow of water through the soil. Equipment is simple and can be used in confined spaces. See Bell (1993)  |
| Injection grouting using chemical and solution (acrylic) grouts | Tunnels and shafts in medium sands (chemical grouts), fine sands and silts (resin grouts)                                    | Materials (chemicals and resin) can be expensive. Silty soils are difficult and treatment may be incomplete, particularly if more permeable lamination or lenses are present. See Bell (1993)  |
| <b>Other types</b>  |  |  |
| Ground freezing using brine or liquid nitrogen                  | Tunnels and shafts. Will not work if groundwater flow velocities are excessive ( $>1 \text{m/day}$ or $10^{-5} \text{m/s}$ ) | Temporary. A 'wall' of frozen ground (a freeze wall) is formed, which can support the side of the shaft as well as excluding groundwater. Plant costs are relatively high. Liquid nitrogen is expensive but quick; brine is cheaper but slower. See Harris (1995)                |
| Compressed air  | Confined chambers such as tunnels, shafts and caissons   | Temporary. Increased air pressure (up to 3.5Bar) raises pore water pressure in the soil around the chamber, reducing the hydraulic gradient and limiting groundwater inflow. High running and set up costs; potential health hazards to workers. See Jardine and McCallum (1994) |

TABLE B.2 SUMMARY OF PRINCIPAL PUMPED WELL GROUNDWATER CONTROL METHODS

| Method   | Typical Application  | Comment   |
|--|--|---|
| Drainage pipes or ditches (eg french drains)         | Control of surface water and shallow groundwater (including overbleed)   | May obstruct construction traffic, and will not control groundwater at depth. Unlikely to be effective in reducing pore water pressures in fine grained soils   |
| Sump pumping   | Shallow excavations in clean coarse soils  | Cheap and simple. May not give sufficient drawdown to prevent seepage from emerging on the cut face of a slope, possibility leading to instability  |
| Wellpoints   | Generally shallow, open excavations in sandy gravels down to fine sands and possibly silty sands. Deeper excavations (requiring >5-6m drawdown) will require multiple stages of wellpoints to be installed | Relatively cheap and flexible. Quick and easy to install in sands. Difficult to install in ground containing cobbles or boulders. Maximum drawdown is ~6m for a single stage in sandy gravels and fine sands, but may only be ~4m in silty sands.                             |
| Deepwells with electric submersible pumps            | Deep excavations in sandy gravels to fine sands and water bearing fissured rocks   | No limit on drawdown. Expensive to install, but fewer wells may be required compared with most other methods. Close control can be exercised over well screen and filter  |
| Shallow bored wells with suction pumps               | Shallow excavations in sandy gravels to silty fine sands and water bearing fissured rocks  | Particularly suitable for coarse, high permeability materials where flowrates are likely to be high. Closer control can be exercised  |
| Passive relief wells and sand drains                 | Relief of pore water pressure in confined aquifers or sand lenses below the floor of the excavation  | Cheap and simple. Create a vertical flowpath for water into the excavation; water must then be directed to a sump and pumped away   |
| Ejector system                                       | Excavations in silty fine sands, silts or laminated clays in which pore water pressure control is required   | In practice drawdowns generally limited to 30-50m. Low energy efficiency, but this is not a problem if flowrates are low. In sealed wells a vacuum is applied to the soil, promoting drainage   |
| Deepwells with electric submersible pumps and vacuum | Deep excavations in silty fine sands, where drainage from the soil into the well may be slow   | No limit on drawdown. More expensive than ordinary deepwells because of the separate vacuum system. Number of wells may be dictated by the requirements to achieve an adequate drawdown between wells, rather than the flowrate, and an ejector system may be more economical |
| Electroosmosis                                       | Very low permeability soils e.g. clays   | Only generally used for pore water pressure control when considered as an alternative to ground freezing. Installation and running costs are comparatively high   |



FIGURE B.1: APPROXIMATE RANGE OF APPLICATION OF GROUNDWATER CONTROL TECHNIQUES IN SOILS



**Appendix C:  
LINING SYSTEMS**

## C.1 TESTING OF CLAY LINERS

### C.1.1 SUITABILITY TESTING

|                            |   |
|----------------------------|---|
| Plastic limit              | (BS1377:1990 Part 2 Method 5.3)   |
| Liquid Limit               | Four Point Method (BS1377:1990 Part 2 Method 4.3)<br>Single Point Method (BS1377:1990 Part 2 Method 4.4)  |
| Plasticity Index           | (BS1377:1990 Part 2 Method 5.4)   |
| Particle Size Distribution | Wet Sieve (BS1377:1990 Part 2 Method 9.2)<br>Dry Sieve (BS1377:1990 Part 2 Method 9.3)<br>Pipette Method (BS1377:1990 Part 2 Method 9.4)<br>Hydrometer Method (BS1377:1990 Part 2 Method 9.5) |

### C.1.2 ACCEPTABILITY TESTING

#### Physical Design Tests

#### 1. Tests for Construction Control

|                   |  |
|-------------------|--|
| Compaction Series | Light Hammer (2.5kg) rammer (BS1377:1990 Part 4 Method 3.3)<br>Heavy Hammer (4.5kg) rammer (BS1377:1990 Part 4 Method 3.5)<br>MCV Compaction (BS1377:1990 Part 4 Method 5.5) |
| Particle Density  | (BS1377:1990 Part 2 Method 8)  |
| Moisture Content  | (BS1377:1990 Part 2 Method 3.2)  |

#### 2. Tests to assess permeability and advection properties

Permeability by water on laboratory prepared samples (leachate tests may also be carried out in general accordance with the following. Other test methods are available).

\* indicates those tests in more common usage

|  |  |
|--|--|
| Triaxial Constant Head                       | (BS1377:1990 Part 6 Method 6)*   |
| Hydraulic Consolidation Cell Constant Head   | (BS1377:1990 Part 6 Method 4)  |
| Triaxial Constant and Falling Head           | (Head 1986 Tests 20.4.1 to 20.4.4)   |
| Falling Head Permeameter                     | (Head 1981 Test 10.7.2)*   |
| Falling Head Test in Sample Tube             | (Head 1981 Test 10.7.3)  |
| Falling Head Test in Oedometer Cell          | (Head 1981 Test 10.7.4)  |
| Falling Head Test in Rowe Consolidation Cell | (Horizontal and Vertical Permeability)<br>(Head 1986 Test 24.7.2 and 27.7.3) |

#### 3. Tests to mitigate physical damage

|  |   |
|--|---|
| Shear Strength (on recompacted samples):                 |   |
| Hand Shear Vane  | (BS1377:1990 Part 7 Method 3)   |
| Undrained Triaxial Strength                              | (BS1377:1990 Part 7 Method 8)   |
| Shear Box:   | Small (BS1377:1990 Part 7 Method 4)<br>Large (BS1377:1990 Part 7 Method 5)  |
| Consolidated Undrained Effective Triaxial Stress         |   |
| Consolidated Drained Effective Triaxial Stress           |   |
| Dispersivity   | Pinhole Test (BS1377:1990 Part 5 Method 6.2)<br>Crumb Test (BS1377:1990 Part 5 Method 6.3)<br>Dispersion Test (BS1377:1990 Part 5 Method 6.4)<br>Chemical Tests (Head 1981 Test 10.8.5) |
| Linear Shrinkage   | (BS1377:1990 Part 2 Method 6.5)   |
| Oedometer Consolidation Test<br>(on recompacted samples) | (BS1377:1990 Part 5 Method 3)   |

### Chemical Design Tests

1. Tests to assess diffusion and attenuation properties
  - Batch Tests (ASTM 1979)
  - Leachate Column Tests
  - Cation Exchange Capacity
  - Anion Exchange Capacity
  - Organic Carbon Content (measured by CO<sub>2</sub> infra-red spectrometer)
  - Mass Loss on Ignition (BS1377:1990 Part 3 Method 4)
  - Carbonaceous Content by High Temperature Loss on Ignition
  - Clay Mineralogy by X-Ray Defraction
2. Tests to assess the influence of leachate chemistry
  - Tests in accordance with ETC8 (German Geotechnical Society, 1993) to characterise the leachate and in accordance with other tests herein to assess the influence.

### CQA Tests

1. Tests to check on material suitability
 

|                            |   |
|----------------------------|---|
| Plastic limit              | (BS1377:1990 Part 2 Method 5.3)   |
| Liquid Limit               | Four Point Method (BS1377:1990 Part 2 Method 4.3)<br>Single Point Method (BS1377:1990 Part 2 Method 4.4)  |
| Plasticity Index           | (BS1377:1990 Part 2 Method 5.4)   |
| Particle Size Distribution | Wet Sieve (BS1377:1990 Part 2 Method 9.2)<br>Dry Sieve (BS1377:1990 Part 2 Method 9.3)<br>Pipette Method (BS1377:1990 Part 2 Method 9.4)<br>Hydrometer Method (BS1377:1990 Part 2 Method 9.5) |
2. Tests to check on material acceptability
 

|  |  |
|--|--|
| MCV Compaction   | (BS1377:1990 Part 4 Method 5.5)  |
| Shear Strength ( <i>in situ</i> or on undisturbed samples):                                |  |
| Hand Shear Vane  | (BS1377:1990 Part 7 Method 3)  |
| Undrained Triaxial Strength  | (BS1377:1990 Part 7 Method 8)  |
| Shear Box  | Small (BS1377:1990 Part 7 Method 4)<br>Large (BS1377:1990 Part 7 Method 5)   |
| Permeabilty by water on undisturbed samples (* indicates those tests in more common usage) |  |
| Triaxial Constant Head   | (BS1377:1990 Part 6 Method 6)*   |
| Hydraulic Consolidation Cell Constant Head   | (BS1377:1990 Part 6 Method 4)  |
| Triaxial Constant and Falling Head   | (Head 1986 Tests 20.4.1 to 20.4.4)   |
| Faling Head Permeameter  | (Head 1981 Test 10.7.2)*   |
| Falling Head Test in Sample Tube   | (Head 1981 Test 10.7.3)  |
| Falling Head Test in Oedometer Cell  | (Head 1981 Test 10.7.4)  |
| Falling Head Test in Rowe Consolidation Cell   | (Horizontal and Vertical Permeability)<br>(Head 1986 Test 24.7.2 and 27.7.3) |
| Permeability ( <i>in-situ</i> )  |  |
| Ponding Tests  |  |
| Ring Infiltrimeter (eg ASTM D5093, 1990)   |  |
| Lysimeter  |  |
| Density <i>in situ</i> or on undisturbed samples (* indicates tests in more common usage)  |  |
| Sand Replacement   | (BS1377:1990 Part 9 Method 2.1)*   |
| Cores  | (BS1377:1990 Part 9 Method 2.4)*   |
| Nuclear Density Measurements   | (BS1377:1990 Part 9 Method 2.5)*   |

Rubber Balloon Method  
Immersion in Water  
Water Displacement Method

(ASTM Test D 2167, 1990)  
(BS1377:1990 Part 2 Method 7.3)  
(BS1377:1990 Part 2 Method 7.4)

## C.2 GEOMEMBRANES

TABLE C.1: ADVANTAGES/DISADVANTAGES OF BASIC POLYMERS OF GEOMEMBRANES

| Advantage   | Disadvantage   |
|---|--|
|   | <b><i>Polyvinyl chloride (PVC) thermoplastic</i></b>   |
| low cost<br>tough without reinforcement<br>lightweight as single ply<br>good seams -dielectric, solvent, and heat<br>large variation in thickness | plasticised for flexibility<br>poor weathering, backfill cover required<br>plasticiser leaches over time<br>poor cold crack resistance<br>poor high temperature performance<br>blocking possible |
|   | <b><i>Chlorinated polyethylene (CPE) thermoplastic</i></b>   |
| good weathering resistance<br>easy seams dielectric and solvent<br>cold crack resistance is good<br>chemical resistance is good                   | moderate cost<br>plasticised with PVC<br>seam reliability<br>delamination possible   |
|   | <b><i>Chlorosulphonated polyethylene (CSPE) thermoplastic rubber</i></b>   |
| excellent weathering resistance<br>cold crack resistance is good<br>chemical resistance is good<br>good seams - heat and adhesive                 | moderate cost<br>fair performance in high temperatures<br>blocking possible  |
|   | <b><i>Elasticised polyolefin (3110) thermoplastic EPDM - cured rubbers</i></b>   |
| good weathering resistance<br>lightweight as single ply<br>cold crack resistance is good<br>chemical resistance is good                           | unsupported only<br>poor high temperature performance<br>field repairs are difficult   |
|   | <b><i>EPDM (4060) thermoplastic rubbers</i></b>  |
| good weathering resistance<br>cold crack resistance<br>good seams - heat bonded<br>no adhesive required   | moderate cost<br>fair in high temperatures<br>blocking possible<br>fair chemical resistance  |
|   | <b><i>Butyl, butyl/EPD, EPDM -cured rubber</i></b>   |
| fair to good weathering resistance<br>low permeability to gases<br>high temperature resistance is good<br>non blocking                            | moderate to high cost<br>poor field seams<br>small panels<br>fair chemical resistance  |
|   | <b><i>Chloroprene (neoprene) cured rubber</i></b>  |
| good weathering resistance<br>good high temperature resistance<br>good chemical resistance  | high cost<br>fair field seams - solvent and tape<br>fair seams to foreign surfaces   |
|   | <b><i>High density polyethylene (HDPE) semicrystalline thermoplastic</i></b>   |
| chemical resistance is excellent<br>good seams - thermal and extrusion<br>large variation in thickness<br>low cost                                | low friction surfaces<br>stress crack sensitive<br>seam workmanship critical<br>high thermal expansion/contraction   |
|   | <b><i>Medium, low, very low density polyethylene (MDPE, LDPE, VLDPE) semicrystalline thermoplastic</i></b>   |
| chemical resistance is good<br>good seams - thermal and extrusion<br>large variation in thickness<br>low cost                                     | moderate thermal expansion/contraction<br>low friction surfaces<br>seam workmanship critical   |
|   | <b><i>Linear low density polyethylene (LLDPE) semicrystalline thermoplastic</i></b>  |
| chemical resistance is good<br>good seams - thermal and extrusion<br>large variation in thickness<br>high friction surfaces<br>no stress crack    | moderate cost  |

### C.3 LEAKAGE THROUGH LINERS

#### C.3.1 CALCULATED RATE OF LEAKAGE PER UNIT AREA FOR VARIOUS THICKNESSES OF MINERAL LINER

Seepage of leachate through a mineral liner is governed by the thickness of liner, head of leachate above the liner, and the hydraulic conductivity of the liner material. Using Darcy's law, ( $Q=kiA$ ) and assuming values of unity for head of leachate ( $h$ ) and  $A$ , it is possible to calculate the rate of leakage per unit area for various thicknesses of mineral liner. The numerical analyses presented are valid if the groundwater is at or below the underside of the liner. The results are shown in Table C.2 and illustrated in Figure C.1.

TABLE C.2: RELATIONSHIP BETWEEN LINER THICKNESS AND RATE OF LEAKAGE PER UNIT AREA

| Thickness of mineral layer<br>$L$ (m) | Hydraulic gradient<br>$i = (h+L)/L$ (m/m) | Rate of leakage per unit area<br>$q = ki$ (m/s) |
|---------------------------------------|---|---|
| 0.5                                   | 3.00                                      | $3.00 \times 10^{-9}$                           |
| 1.0                                   | 2.00                                      | $2.00 \times 10^{-9}$                           |
| 2.0                                   | 1.50                                      | $1.50 \times 10^{-9}$                           |
| 3.0                                   | 1.33                                      | $1.33 \times 10^{-9}$                           |
| 4.0                                   | 1.25                                      | $1.25 \times 10^{-9}$                           |
| 5.0                                   | 1.20                                      | $1.20 \times 10^{-9}$                           |
| 6.0                                   | 1.17                                      | $1.170 \times 10^{-9}$                          |

Notes: leachate head ( $h$ ) = 1m,  
hydraulic conductivity ( $k$ ) =  $1 \times 10^{-9}$  m/s

FIGURE C.1: CALCULATED RATE OF LEAKAGE PER UNIT AREA FOR VARIOUS THICKNESSES OF MINERAL LINER

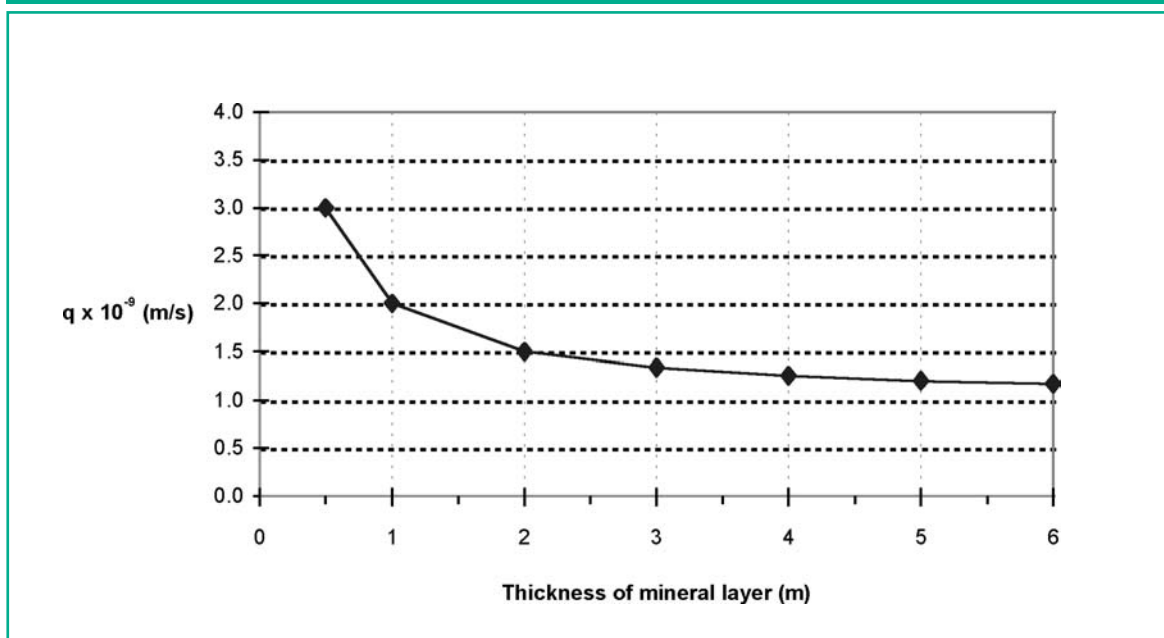



C.3.2 CALCULATED RATE OF LEAKAGE PER UNIT AREA FOR VARIOUS LEACHATE HEAD LEVELS THROUGH A 1M THICK MINERAL LINER WITH A HYDRAULIC CONDUCTIVITY OF  $1 \times 10^{-9} \text{M/S}$

Using Darcy’s law, ( $Q=kiA$ ) and assuming values of unity for mineral liner thickness and A, it is possible to calculate the rate of leakage per unit area for various leachate head levels. The numerical analyses presented are valid if the groundwater is at or below the underside of the liner. The results are shown in Table C.3 and illustrated in Figure C.2.

TABLE C.3: RELATIONSHIP BETWEEN LEACHATE HEAD AND RATE OF LEAKAGE PER UNIT AREA

| Leachate head h (m) | Hydraulic gradient $i = (h+L)/L$ (m/m) | Rate of leakage per unit area $q = ki \times 10^{-9}(\text{m/s})$ |
|---------------------|--|---|
| 0.50                | 1.50                                   | 1.50  |
| 1.00                | 2.00                                   | 2.00  |
| 1.50                | 2.50                                   | 2.50  |
| 2.00                | 3.00                                   | 3.00  |
| 2.50                | 3.50                                   | 3.50  |
| 3.00                | 4.00                                   | 4.00  |

FIGURE C.2: CALCULATED RATE OF LEAKAGE PER UNIT AREA FOR VARIOUS HEADS OF LEACHATE

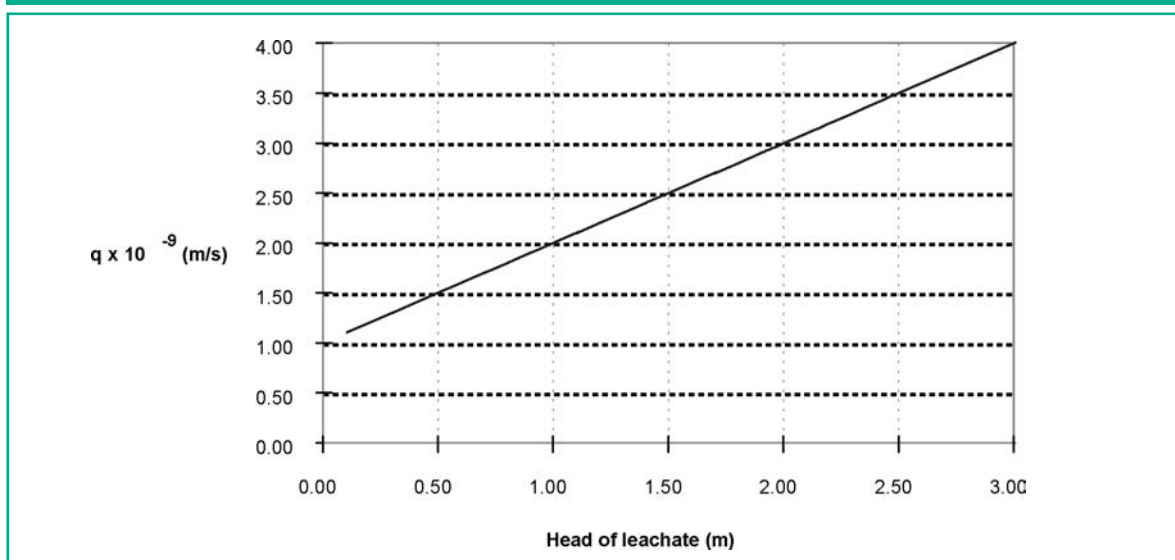

C.3.3 LEAKAGE RATES THROUGH COMPOSITE LINERS

Based on studies by Giroud *et al* (1989) the following equations may be used to evaluate the rate of leakage through a defect in the geomembrane of a composite liner:

$Q = 0.21 a^{0.1} h^{0.9} k^{0.74}$  (for good contact) eqn (1)

$Q = 1.15 a^{0.1} h^{0.9} k^{0.74}$  (for poor contact) eqn (2)

where

Q is the leakage rate ( $\text{m}^3/\text{s}$ )

a is the defect area of the geomembrane ( $\text{m}^2$ )

h is the hydraulic head on top of the liner (m)

k is the hydraulic conductivity of the compacted soil ( $\text{m/s}$ )

The above equations are valid if the hydraulic head above the geomembrane is less than the thickness of the soil component of the composite liner (i.e.,  $h < D$ ) and if the hydraulic conductivity, k, of the soil component of the composite liner is less than  $10^{-6} \text{m/s}$ .

Good contact conditions correspond to a geomembrane, with as few wrinkles as possible, on top of the soil component that has been adequately

compacted and has a smooth surface.

Poor contact conditions correspond to a geomembrane, with a certain number of wrinkles, on top of the soil component that has not been well compacted and does not appear smooth.

If the leachate head on the geomembrane is greater than the thickness of the soil component of the composite liner, i.e.  $h > D$ , the following equations (Giroud *et al*, 1994) can be used:

$$Q = 0.21 i_{avg} a^{0.1} h^{0.9} k^{0.74} \text{ (for good contact) eqn (3)}$$

$$Q = 1.15 i_{avg} a^{0.1} h^{0.9} k^{0.74} \text{ (for poor contact) eqn (4)}$$

where  $i_{avg}$  is a dimensionless factor given in Figure C.3.

Equations (3) and (4) may not be applicable, as in the construction of new landfills the leachate head should never be designed to exceed the thickness of the compacted soil component.

Equation (1) should be applicable as good contact between geomembrane and the compacted soil component can be assumed with strict construction quality assurance and proper construction.

Typically geomembrane liners installed with strict construction quality assurance have a frequency of one to two defects per 4000m<sup>2</sup> with a diameter of 2mm (Giroud and Bonaparte, 1989a). Leakage rates for different hydraulic heads and different hydraulic conductivity's have been evaluated using eqn (1) (good contact) and are presented in Table C.4 and illustrated in Figure C.4. These have been calculated for areas of 0.1cm<sup>2</sup> and 1cm<sup>2</sup> with two defects per 4000m<sup>2</sup> and are expressed in litres/hectare/day.

TABLE C.4: LEAKAGE RATE PER UNIT AREA IN LITRE PER HECTARE PER DAY

| Defect area<br>a (m <sup>2</sup> )           | Hydraulic<br>Conductivity<br>k (m/s) | Hydraulic Head, h (m) |       |        |        |        |
|--|--------------------------------------|-----------------------|-------|--------|--------|--------|
|  |                                      | 0.10                  | 0.30  | 0.50   | 0.75   | 1.00   |
| Leakage Rate, Q (litres per hectare per day) |                                      |                       |       |        |        |        |
| 1.00E-05                                     | 1.00E-07                             | 23.86                 | 64.14 | 101.57 | 146.30 | 189.54 |
| 1.00E-05                                     | 1.00E-08                             | 4.34                  | 11.67 | 18.48  | 26.62  | 34.49  |
| 1.00E-05                                     | 1.00E-09                             | 0.79                  | 2.12  | 3.36   | 4.84   | 6.28   |
| 1.00E-04                                     | 1.00E-07                             | 30.04                 | 80.74 | 127.87 | 184.19 | 238.62 |
| 1.00E-04                                     | 1.00E-08                             | 5.47                  | 14.69 | 23.27  | 33.52  | 43.42  |
| 1.00E-04                                     | 1.00E-09                             | 0.99                  | 2.67  | 4.23   | 6.10   | 7.90   |

Notes Estimates using eqn (1) with 2 defects per 4000m<sup>2</sup>  
In the case of poor contact conditions, leakage rates have to be multiplied by 5.5.

FIGURE C.3: VALUE OF  $I_{AVG}$

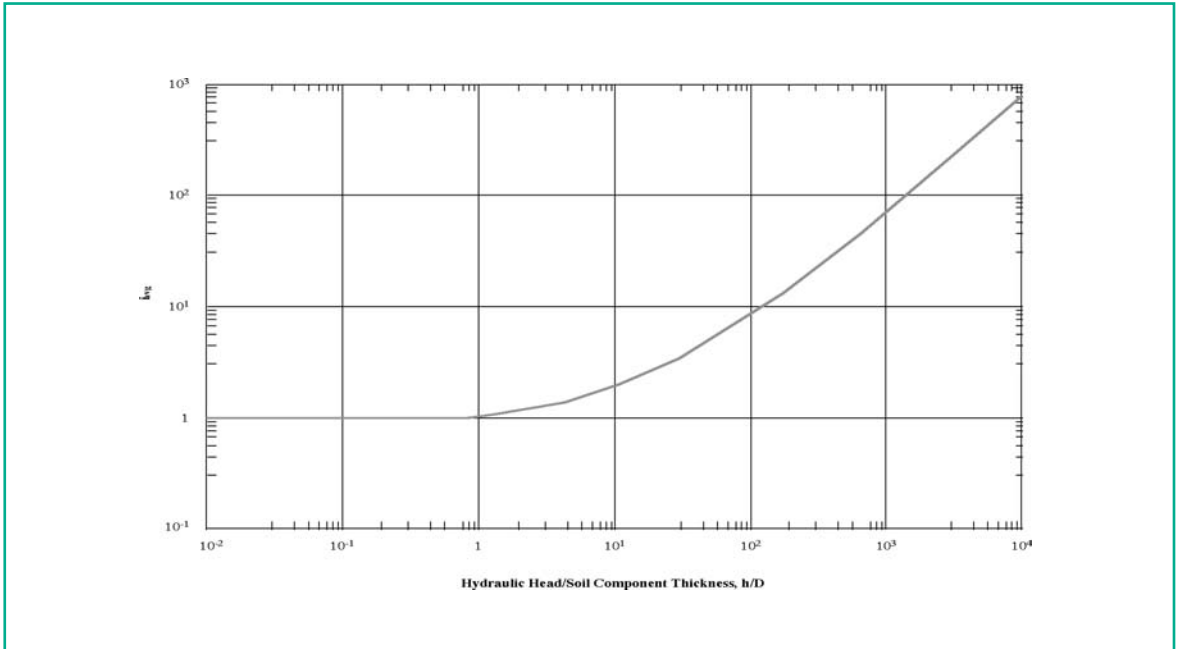
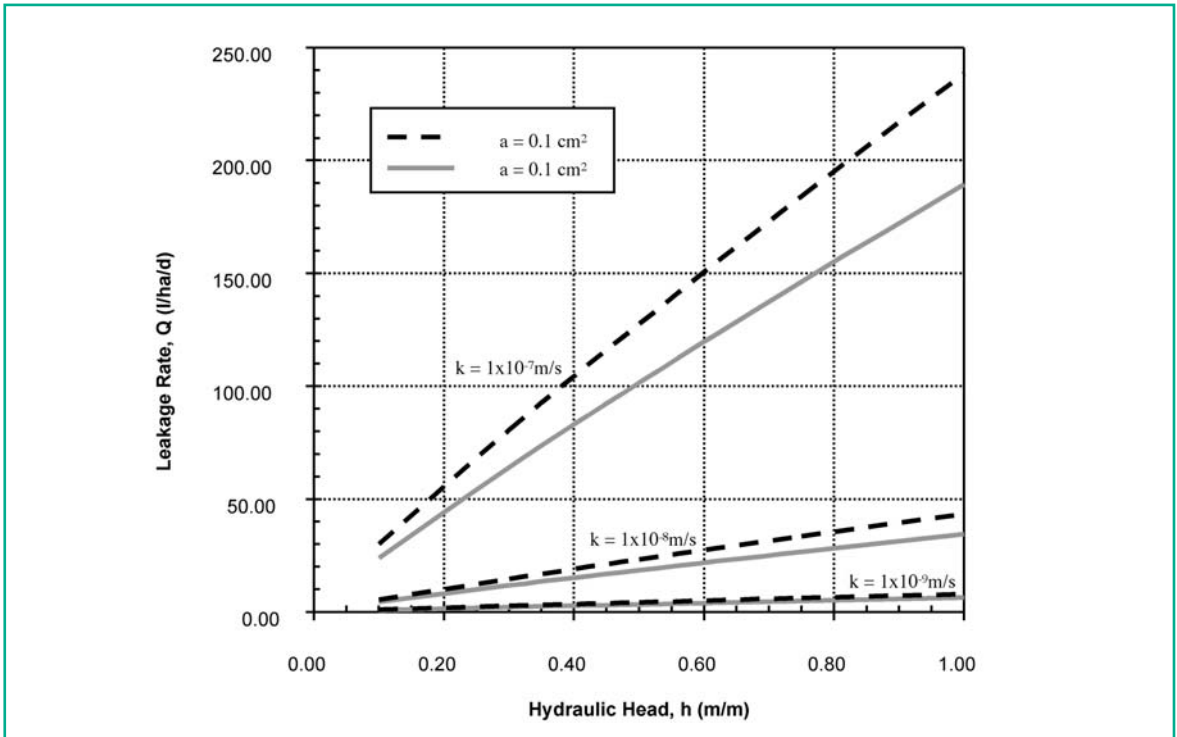

FIGURE C.4: LEAKAGE RATES FOR VARIATION IN HYDRAULIC HEAD AND HYDRAULIC CONDUCTIVITY FOR A COMPOSITE LINER WITH GOOD CONTACT BETWEEN GEOMEMBRANE AND SOIL COMPONENT



**Appendix D:  
LEACHATE MANAGEMENT/TREATMENT**

## D1 CONSTITUENTS OF INERT AND HAZARDOUS LEACHATE

TABLE D.1: CONSTITUENTS OF INERT AND HAZARDOUS LEACHATE

| Determinand                           | Inert Leachate |      | Hazardous Leachate         |                              |
|---------------------------------------|----------------|------|----------------------------|------------------------------|
|                                       | Germany        | UK   | Germany<br>(old landfills) | Germany<br>(other landfills) |
| pH-value                              | 7.5            | 8.1  | 6.3-7.6                    | 5.9-11.6                     |
| conductivity (mS/m)                   | 250            | n.r. | n.r.                       | n.r.                         |
| COD (mg/l)                            | 130            | 236  | 2320-29300                 | 50-35000                     |
| BOD <sub>5</sub> (mg/l)               | 20             | n.r. | 850-15000                  | 41-15000                     |
| TOC (mg/l)                            | 40             | 93   | n.r.                       | n.r.                         |
| AOX (mg/l)                            | n.r.           | n.r. | 4-292                      | 0.04-36.5                    |
| phenols (mg/l)                        | n.r.           | n.r. | 5.4-35                     | <0.01-350                    |
| ammmoniacal-N (mgN/l)                 | 13             | 28   | 28-3670                    | <5-6036                      |
| sulphate (as SO <sub>4</sub> ) (mg/l) | 450            | 212  | 30-7120                    | 18-14968                     |
| chloride (mg/l)                       | 100-600        | 373  | 300-126300                 | 36-36146                     |
| sodium (mg/l)                         | 270            | 104  | n.r.                       | n.r.                         |
| potassium (mg/l)                      | 50             | 50   | n.r.                       | n.r.                         |
| magnesium (mg/l)                      | 30             | 47   | n.r.                       | n.r.                         |
| calcium (mg/l)                        | 200            | 335  | n.r.                       | n.r.                         |
| iron (mg/l)                           | 3.5            | 70   | 1.4-2700                   | 0.38-95.8                    |
| zinc (mg/l)                           | 0.1-0.2        | n.r. | 0.14-3.5                   | 0.02-27.24                   |
| nickel(µg/l)                          | 7              | n.r. | 16-1000                    | 14.2-30000                   |
| copper(µg/l)                          | 1-11           | n.r. | 37-300                     | 1.3-8000                     |
| arsenic(µg/l)                         | 9-37           | n.r. | 2-71                       | <2-240                       |
| mercury(µg/l)                         | n.d.           | n.r. | 0.56-7                     | 0.17-50                      |
| lead(µg/l)                            | 3-6            | n.d. | 6-650                      | 4.3-525                      |
| No of landfills                       | 3              | 6    | 7                          | 28                           |

Notes:  
Hjelmar *et al.*, 1994  
n.d. not detectable, n.r. not reported

**D.2 COMPARATIVE PERFORMANCE OF VARIOUS TREATMENT PROCESSES FOR LEACHATE TREATMENT**

**TABLE D.2: COMPARATIVE PERFORMANCE OF VARIOUS TREATMENT PROCESSES FOR LEACHATE TREATMENT**

| Treatment Processes        | Organics<br>Young<br>(<5yr) | Organics<br>Middle<br>(5-10yr) | Organics<br>Old<br>(>12yr) | Metals | VOCs | Nitrogen | Priority<br>Pollutants | Solids | Comments                |
|----------------------------|-----------------------------|--------------------------------|----------------------------|--------|------|----------|------------------------|--------|-------------------------|
| <b>Physical - Chemical</b> |                             |                                |                            |        |      |          |                        |        |                         |
| Air Stripping              | NA                          | NA                             | NA                         | NA     | Good | Good     | Fair                   | NA     | Needs off gas treatment |
| Coagulation/precipitation  | Poor                        | Fair                           | Poor                       | Good   | NA   | Poor     | NA                     | Good   |                         |
| <b>Biological</b>          |                             |                                |                            |        |      |          |                        |        |                         |
| Aerobic suspended growth   | Good                        | Fair                           | Poor                       | Good   | Good | Fair     | Fair                   | Fair   |                         |
| Aerobic fixed film         | Good                        | Fair                           | Poor                       | Good   | Good | Fair     | Fair                   | Fair   |                         |
| Anaerobic (UASB)           | Good                        | Fair                           | Poor                       | Good   | Good | Poor     | Fair                   | Fair   |                         |
| <b>Advanced/Tertiary</b>   |                             |                                |                            |        |      |          |                        |        |                         |
| Carbon adsorption          | Poor                        | Fair                           | Good                       | NA     | Good | NA       | Good                   | NA     | Needs pretreatment      |
| Membrane processes         | Good                        | Good                           | Good                       | Good   | Fair | Good     | Good                   | Good   | Needs pretreatment      |
| Chemical Oxidation         | Poor                        | Fair                           | Fair                       | NA     | Fair | NA       | Good                   | NA     |                         |

Note 1. Modified from Qasim and Chian (1994).  
 Note 2. NA = not applicable

(TABLE D.2 CONT.)

| Treatment Processes        | Land Requirements | Ability to handle flow variations | Ability to handle influent quality variations | Reliability of the process | Ease of operation of the process | Ease of upgrading process change | Waste products |
|----------------------------|-------------------|-----------------------------------|---|----------------------------|----------------------------------|----------------------------------|----------------|
| <b>Physical - Chemical</b> |                   |                                   |   |                            |                                  |                                  |                |
| Air Stripping              | Small             | Fair                              | Fair  | Good                       | Fair                             | Poor                             | Ammonia        |
| Coagulation/precipitation  | Medium            | Good                              | Good  | Good                       | Fair                             | Good                             | Sludge         |
| <b>Biological</b>          |                   |                                   |   |                            |                                  |                                  |                |
| Aerobic suspended growth   | Large             | Good                              | Fair  | Good                       | Good                             | Good                             | Sludge         |
| Aerobic fixed film         | Large             | Fair                              | Good  | Good                       | Good                             | Poor                             | Sludge         |
| Anaerobic (UASB)           | Medium            | Good                              | Fair  | Good                       | Fair                             | Fair                             | Sludge         |
| <b>Advanced/Tertiary</b>   |                   |                                   |   |                            |                                  |                                  |                |
| Carbon adsorption          | Small             | Poor                              | Poor  | Good                       | Fair                             | Fair                             | Spent Carbon   |
| Membrane processes         | Small             | Poor                              | Good  | Good                       | Fair                             | Fair                             | Brine          |
| Chemical Oxidation         | Small             | Fair                              | Fair  | Fair                       | Poor                             | Fair                             | Sludge         |

Note 1. Modified from Qasim and Chian (1994).

Note 2. NA = not applicable

### D.3 MONITORING REQUIREMENTS

The following details **are examples** of the level of control and monitoring that may be required for the treatment of leachate in an **Aeration Basin** in a waste licence from the EPA. Obviously, the degree of sophistication and control would vary on a case-by-case basis.

**Emission Point Reference No.:** E-1

**Description of Treatment:** Waste Water Treatment

| Monitoring to be Carried Out <sup>a</sup> | Monitoring Frequency <sup>a</sup> | Monitoring Equipment/Method <sup>a</sup> |
|---|-----------------------------------|--|
| TOC, BOD, COD (ex Balance Tank)           | Continuous/Daily/Weekly           | TOC Recorder/Standard Methods            |
| Ammonia (ex Balance Tank)                 | Continuous/Daily/Weekly           | Ammonia ion selective electrode          |
| Flow (ex Balance Tank)                    | Continuous/Daily/Weekly           | Flow Meter/Recorder                      |
| pH (ex Balance Tank)                      | Continuous/Daily/Weekly           | pH Meter/Recorder                        |
| Conductivity (ex Balance Tank)            | Continuous/Daily/Weekly           | Meter/Recorder                           |
| Dissolved Oxygen (Aeration Basin)         | Continuous/Daily/Weekly           | DO Meter/Recorder                        |
| TOC, BOD, COD (Final Effluent)            | Continuous/Daily/Weekly           | TOC Recorder/Standard Methods            |
| Ammonia (Final Effluent)                  | Continuous/Daily/Weekly           | Ammonia ion selective electrode          |
| Flow (Final Effluent)                     | Continuous/Daily/Weekly           | Flow Meter/Recorder                      |
| pH (Final Effluent)                       | Continuous/Daily/Weekly           | pH Meter/Recorder                        |
| Conductivity (Final Effluent)             | Continuous/Daily/Weekly           | Meter/Recorder                           |
| Mixed Liquor Suspended Solids             | Daily/Weekly                      | Standard Methods                         |
| Sludge Volume Index                       | Daily/Weekly                      | Standard Methods                         |

<sup>a</sup> The frequency, methods and scope of monitoring, sampling and analysis may be amended following evaluation of the test results.

#### Equipment:

| Control Parameter  | Equipment   | Backup equipment  |
|--------------------|---|---|
| Effluent Transfer  | Lift Pumps  | Standby pumps and spares held on site                           |
| Effluent Balancing | Agitator<br>Feed-forward pump   | Spares held on site<br>Spares held on site                      |
| Dissolved Oxygen   | Three surface aerators<br>Six submerged flight mixers<br>Fixed DO Meter | Spares held on site<br>Spares held on site<br>Portable DO Meter |
| Suspended Solids   | Sludge transfer pumps (x2)  | Spares held on site   |



**Appendix E:  
LANDFILL GAS MANAGEMENT**

TABLE E.1: TYPICAL LANDFILL GAS COMPOSITION (SOURCE UK DOE )

| Component                | Typical value<br>(% volume) | Observed Maximum<br>(% volume) |
|--------------------------|-----------------------------|--------------------------------|
| Methane                  | 63.8                        | 88.0                           |
| Carbon dioxide           | 33.6                        | 89.3                           |
| Oxygen                   | 0.16                        | 20.9                           |
| Nitrogen                 | 2.4                         | 87                             |
| Hydrogen                 | 0.05                        | 21.1                           |
| Carbon monoxide          | 0.001                       | 0.09                           |
| Ethane                   | 0.005                       | 0.0139                         |
| Ethene                   | 0.018                       | -                              |
| Acetaldehyde             | 0.005                       | -                              |
| Propane                  | 0.002                       | 0.0171                         |
| Butanes                  | 0.003                       | 0.023                          |
| Helium                   | 0.00005                     | -                              |
| Higher alkanes           | <0.05                       | 0.07                           |
| Unsaturated hydrocarbons | 0.009                       | 0.048                          |
| Halogenated compounds    | 0.00002                     | 0.032                          |
| Hydrogen sulphide        | 0.00002                     | 35.0                           |
| Organosulphur compounds  | 0.00001                     | 0.028                          |
| Alcohols                 | 0.00001                     | 0.127                          |
| Others                   | 0.00005                     | 0.023                          |

TABLE E.2: TYPICAL INSTRUMENTATION FOR USE WITH LANDFILL GAS

| Measurement Variable  | Measurement Options       | Typical Ranges                        |
|---|---------------------------|---------------------------------------|
| Temperature   | Mechanical dial gauge     | 0-80°C                                |
|   | Thermocouple              | 100-1250°C                            |
|   | Thermister                | -50-+50°C                             |
| Pressure  | Platinum-film resistor    | -50-+1250°C                           |
|   | Bourdon dial gauge        | -150-+500mb                           |
|   | Diaphragm switch          |                                       |
| Flow rate   | Transducer                |                                       |
|   | Orifice plate             | 0.1-1.0m <sup>3</sup> s <sup>-1</sup> |
|   | Pitot tube                |                                       |
|   | Turbine meter             |                                       |
|   | Venturi meter             |                                       |
| Methane content   | Mechanical gas meter      |                                       |
|   | Infra-red sensor          | 0-100% v/v                            |
|   | Pellistor                 | 0-80% v/v                             |
| Carbon dioxide content  | Flame ionisation detector | 0.1-10,000ppm                         |
|   | Infra-red sensor          | 0-50% v/v                             |
| Oxygen content  | Chemical cell             | 0-25% v/v                             |
|   | Paramagnetic cell         |                                       |
| Trace components<br>(halogenated compounds,<br>hydrocarbons etc.) | Draeger tubes             | <1->1000ppm                           |
|   | Gas chromatograph         |                                       |
|   | Photo ionisation detector |                                       |

# An Ghníomhaireacht um Chaomhnú Comhshaoil

## Bunú

Achtaíodh an tAcht fán nGníomhaireacht um Chaomhnú Comhshaoil ar an 23ú lá d'Aibreán, 1992 agus faoin reachtaíocht seo bunaíodh an Ghníomhaireacht go hoifigiúil ar an 26ú lá d'Iúil, 1993.

## Cúraimí

Tá réimse leathan de dhualgais reachtúla ar an nGníomhaireacht agus de chumhachtaí reachtúla aici faoin Acht. Tá na nithe seo a leanas san áireamh i bpríomhfhreagrachtaí na nGníomhaireachta:

- ceadúnú agus rialáil próiseas mór/ilchasta tionsclaíoch agus próiseas eile a d'fhéadfadh a bheith an-truaillitheach, ar bhonn rialú comhtháite ar thruailliú (Integrated Pollution Control-IPC) agus cur chun feidhme na dteicneolaíochtaí is fearr atá ar fáil chun na críche sin;
- faireachán a dhéanamh ar cháilíocht comhshaoil, lena n-áirítear bunachair sonraí a chur ar bun a mbeidh rochtain ag an bpobal orthu, agus foilsiú tuarascálacha treimhsiúla ar staid an chomhshaoil;
- comhairle a chur ar údarais phoiblí maidir le feidhmeanna comhshaoil agus cuidiú le húdarais áitiúla a bhfeidhmeannas caomhnaithe a chomhlíonadh;
- cleachtais atá fóna ó thaobh an chomhshaoil de a chur chun cinn, mar shampla, trí úsáid iniúchtaí comhshaoil a spreagadh, cuspóirí cáilíochta comhshaoil a leagan síos agus cóid chleachtais a eisiúint maidir le nithe a théann i bhfeidhm ar an gcomhshaoil;
- taighde comhshaoil a chur chun cinn agus a chomhordú;
- gach gníomhaíocht thábhachtach diúscartha agus aisghabhála dramhaíola, lena n-áirítear líontaí talún, a cheadúnú agus a rialáil agus plean náisiúnta bainistíochta um dhramháil ghuaiseach, a bheidh le cur i ngníomh ag comhlachtaí eile, a ullmhú agus a thabhairt cothrom le dáta go tréimhsiúil;
- córas a fheidhmiú a chuirfidh ar ár gcumas astúcháin COS (Comhdhúiligh Orgánacha Sho-ghalaithe) a rialú de bharr cáinníochtaí suntasacha peitрил a bheith á stóráil i dteirminéil;
- na rialúcháin OMG (Orgánaigh a Mionathraíodh go Géiniteach) a fheidhmiú agus a ghníomhú maidir le húseaid shrianta a leithéad seo d'orgánaigh agus iad a scaoileadh d'aon turas isteach sa timpeallacht;

- clár hidriméadach náisiúnta a ullmhú agus a chur i ngníomh chun faisnéis maidir le leibhéil, toirteanna agus sruthanna uisce in aibhneacha, i lochanna agus i screamhuiscí a bhailiú, a anailisiú agus a fhoilsiú; agus
- maoirseacht i gcoitinne a dhéanamh ar chomhlíonadh a bhfeidhmeanna reachtúla caomhnaithe comhshaoil ag údarás áitiúla.

## Stádas

Is eagrais poiblí neamhspleách í an Ghníomhaireacht. Is í an Roinn Comhshaoil agus Rialtais Áitiúil an coimirceoir rialtais atá aici. Cinntítear a neamhspleáchas trí na modhanna a úsáidtear chun an tArd-Stiúrthóir agus na Stiúrthóirí a roghnú, agus tríd an tsaoirse a dhearbhaíonn an reachtaíocht di gníomhú ar a conlán féin. Tá freagracht dhíreach faoin reachtaíocht aici as réimse leathan feidhmeannas agus cuireann sé seo taca breise lena neamhspleáchas. Faoin reachtaíocht, is coir é iarracht a dhéanamh dul i gcion go míchuí ar an nGníomhaireacht nó ar aon duine atá ag gníomhú thar a ceann.

## Eagrú

Tá ceanncheathrú na nGníomhaireachta lonnaithe i Loch Garman agus tá cúig fhoireann chigireachta aici, atá lonnaithe i mBaile Átha Cliath, Corcaigh, Cill Chainnigh, Caisleán an Bharraigh agus Muineachán.

## Bainistíocht

Riarann Bord Feidhmiúcháin lánaimseartha an Ghníomhaireacht. Tá Ard-Stiúrthóir agus ceathrar Stiúrthóirí ar an mBord. Ceapann an Rialtas an Bord Feidhmiúcháin de réir mionrialacha atá leagtha síos san Acht.

## Coiste Comhairleach

Tugann Coiste Comhairleach ar a bhfuil dáréag ball cunamh don Ghníomhaireacht. Ceapann an tAire Comhshaoil agus Rialtais Áitiúil na bail agus roghnaítear iad, den chuid is mó, ó dhaoine a ainmníonn eagraíochtaí a bhfuil suim acu i gcúrsaí comhshaoil nó forbartha. Tá réimse fairsing feidhmeannas comhairleach ag an gCoiste faoin Acht, i leith na nGníomhaireachta agus i leith an Aire araon.

